



# Sunbank Series User Manual



EN

## Copyright Declaration

The copyright of this manual belongs to SolaX Power Co., Ltd. . Any corporation or individual should not plagiarize, partially copy or fully copy it (including software, etc.), and no reproduction or distribution of it in any form or by any means. All rights reserved. SolaX Power Co., Ltd. reserves the right of final interpretation. This information is subject to changes without notice.

# Contents

<b>1 NOTES ON THIS MANUAL</b>	<b>03</b>
1.1 SCOPE OF VALIDITY	03
1.2 TARGET GROUP	03
1.3 SYMBOLS USED	03
<b>2 SAFETY</b>	<b>04</b>
2.1 APPROPRIATE USAGE	04
2.2 IMPORTANT SAFETY INSTRUCTIONS	05
2.3 EXPLANATION OF SYMBOLS	06
2.4 EC DIRECTIVES	09
<b>3 INTRODUCTION</b>	<b>10</b>
3.1 BASIC FEATURE AND DIFFERENT WORKING MODES	10
3.2 TERMINALS OF GRID TIED STORAGE INVERTER, GRID TIED INVERTER AND CHARGER	10
3.3 DIMENSION	11
3.4 IDENTIFICATION OF SUNBANK	12
<b>4 TECHNICAL DATA</b>	<b>13</b>
4.1 DC INPUT	13
4.2 AC OUTPUT	13
4.3 BATTERY (FOR THE SK-SU)	14
4.4 EFFICIENCY, SAFETY AND PROTECTION	14
4.5 GENERAL DATA	15
<b>5 INSTALLATION</b>	<b>15</b>
5.1 UN PACKING	15
5.2 CHECK FOR TRANSPORT DAMAGE	16
5.3 INSTALLATION PRECAUTION	17
5.4 PREPARATION	18
5.5 INSTALLATION STEPS	19
5.6 CONNECTIONS OF THE PV POWER SYSTEM	20
5.7 RUN THE INVERTER	30

- 6 OPERATION METHOD ..... 31**
  - 6.1 CONTROL PANEL ..... 31
  - 6.2 LCD FUNCTION ..... 32
  - 6.3 LCD OPERATION ..... 35
  
- 7 TROUBLESHOOTING ..... 41**
  - 7.1 TROUBLE SHOOTING ..... 41
  - 7.2 ROUTINE MAINTENANCE ..... 44
  
- 8 DECOMMISSIONING ..... 45**
  - 8.1 DISMANTLING THE INVERTER ..... 45
  - 8.2 PACKAGING ..... 45
  - 8.3 STORAGE ..... 45
  - 8.4 DISPOSAL ..... 45
  
- 9 BATTERY MANAGER ..... 46**
  - 9.1 INTRODUCTION ..... 46
  - 9.2 TECHNICAL DATA ..... 46
  - 9.3 CONNECTING ..... 47

# 1 Notes on this Manual

## 1.1 Scope of Validity

This manual is an integral part of inverter, and it describes the assembly, installation, commissioning, maintenance and failure search of the below inverters. Please read it carefully before operating.

SK-TL3000	SK-TL3700	SK-TL5000
SK-SU3000	SK-SU3700	SK-SU5000
SK-BMU1300		

Store this manual where it will be accessible at all times.

## 1.2 Target Group

This manual is for qualified electricians. The tasks described in this manual only can be performed by qualified electricians.

## 1.3 Symbols Used

The following types of safety instructions and general information appear in this document as described below:



### **DANGER !**

"Danger" indicates a hazardous situation which, if not avoided, will result in death or serious injury.



### **WARNING !**

"Warning" indicates a hazardous situation which, if not avoided, could result in death or serious injury.



### **CAUTION !**

"Caution" indicates a hazardous situation which, if not avoided, could result in minor or moderate injury.



### **NOTE !**

"Note" provides tips that are valuable for the optimal operation of your product.



## 2 Safety

### 2.1 Appropriate Usage

The SunBank includes a grid-tied PV inverter SK-TL which can convert the DC current of the PV generator into AC current and feed it into the public grid and a grid-tied self-use storage PV inverter SK-SU, which can store the energy in the battery for self-use and also can convert the DC current of the PV generator into AC current and feed it into the public grid.

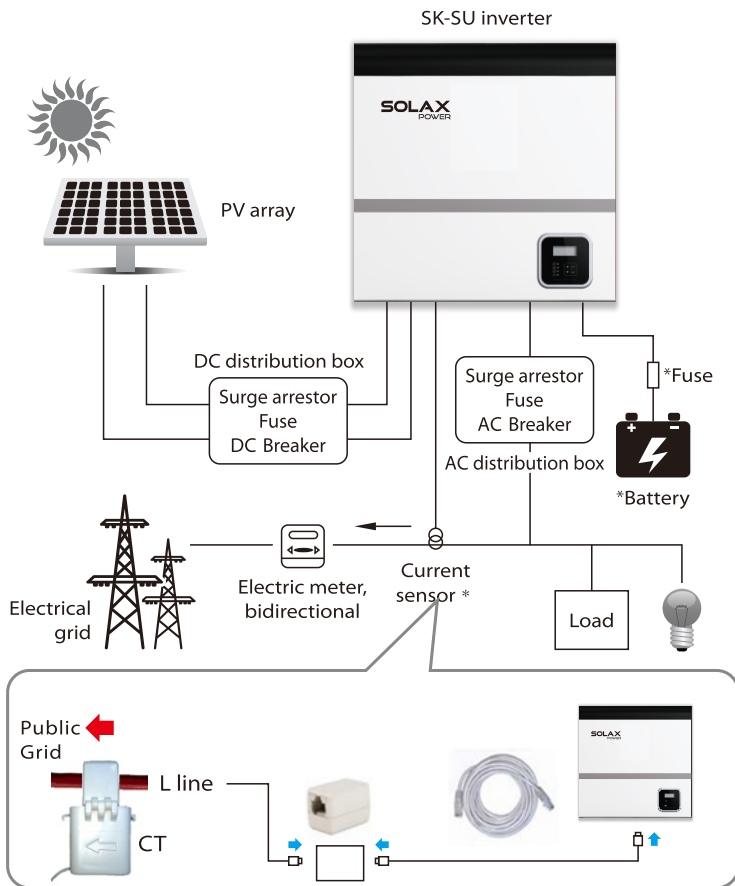

Note: \* For SK-TL series , the fuse and battery are not used.

\* The CT can be replaced with meter if necessary.

## Surge protection devices (SPDs) for PV installation



### WARNING !

Over-voltage protection with surge arresters should be provided when the PV power system installed.  
The grid connected inverter is not fitted with SPDs in both PV input side and MAINS side.

Lighting can cause damage either from direct strike or from surges due to a nearby strike.

Induced surges are the more likely cause of lighting damage in majority of installations, especially in rural areas where electricity is usually by long overhead lines. Surge may be included on both the PV array conduction and the a.c. cables leading to the building.

Specialists in lightning protection should be consulted during the end use application. Using appropriate external lightning protection, the effect of a direct lightning strike into a building can be mitigated in a controlled way, and the lightning current can be discharged into the ground.

Installation of SPDs to protect the inverter against mechanical damage and excessive stress include a surge arrester in case of a building with external lightning protection system (LPS) when separation distance is kept.

To protect the d.c. system, surge suppression device (SPD type2) should be fitted at the inverter end of the d.c. cabling and at the array, located between the inverter and the PV generator, if the voltage protection level (VP) of the surge arresters is greater than 1100V, a additional SPD type 3 required for surge protection for electrical devices.

To protect the a.c system, surge suppression devices (SPD type2) should be fitted at the main incoming point of a.c supply (at the consumer's cutout), located between the inverter and the meter/distribution system; SPD (test impulse D1) for signal line according to EN 61632-1.

All d.c cables should be installed to provide as short runs as possible, and positive and negative cables of the same string or main d.c supply should be bundled together. Avoiding the creation of loops in the system. This requirement for short runs and bundling includes any associated earth/bundling conductors.

Spark gap devices are not suitable to be used in d.c circuits as once conducting, they won't stop conducting until the voltage across their terminals is typically less than 30 volts.

## 2.2 Important Safety Instructions



### DANGER !

#### DANGER TO LIFE DUE TO HIGH VOLTAGES IN THE INVERTER !

- All work on the inverter must be carried out by qualified electrician.
- The appliance is not to be used by children or persons with reduced physical sensory or mental capabilities, or lack of experience and knowledge, unless they have been given supervision or instruction.
- Children should be supervised to ensure that they do not play with the appliance.



**CAUTION !**  
**DANGER OF BURN INJURIES DUE TO HOT ENCLOSURE PARTS !**  
 During operation, the upper lid of the enclosure and the enclosure body may become hot.  
 • Only touch the lower enclosure lid during operation.



**CAUTION !**  
**POSSIBLE DAMAGE TO HEALTH AS A RESULT OF THE EFFECTS OF RADIATION !**  
 • Do not stay closer than 20 cm to the inverter for any length of time.







**NOTE !**  
 Grounding the PV generator.  
 Comply with the local requirements for grounding the PV modules and the PV generator. SolaX recommends connecting the generator frame and other electrically conductive surfaces in a manner which ensures continuous conduction and ground these in order to have optimal protection of the system and persons.

### 2.3 Explanation of Symbols











This section gives an explanation of all the symbols shown on the inverter and on the type label.

• Symbols on the Inverter

Symbol	Explanation
	Operating Display
	The battery is in charging or discharging.
	Communication is active.
	An error has occurred, please inform your installer immediately.

• Symbols on the Type Label

Symbol	Explanation
	CE mark. The inverter complies with the requirements of the applicable CE guidelines.

	TUV certified.
	RCM remark.
	SAA certification.
	Beware of hot surface. The inverter can become hot during operation. Avoid contact during operation.
	Danger of high voltages. Danger to life due to high voltages in the inverter!
	Danger. Risk of electric shock!
	Observe enclosed documentation.
	The inverter can not be disposed of together with the household waste. Disposal information can be found in the enclosed documentation.
	Don't work on this inverter until it is isolated from both mains and on-site PV generation suppliers.
	Danger to life due to high voltage. There is residual voltage in the inverter which needs 5 min to discharge. • Wait 5 min before you open the upper lid or the DC lid.

• **Important Safety Instructions**

When using the product, please do remember the below information to avoid the fire, lightning or other personal injury:



**WARNING !**  
Ensure input DC voltage  $\leq$ Max. DC voltage . Over voltage may cause permanent damage to inverter or other losses, which will not be included in warranty! This chapter contains important safety and operating instructions. Read and keep this Operation Guide for future reference.



**WARNING !**  
Authorized service personnel must disconnect both AC and DC power from the SunBank Series inverter before attempting any maintenance or cleaning or working on any circuits connected to the SunBank Series inverter.

- Read all instructions, cautionary markings on the inverter, and all appropriate sections of this manual before using this inverter.

- Use only attachments recommended or sold by SolaX.
- Make sure that existing wiring is in good condition and that wire is not undersized. Do not operate the SunBank Series inverter with damaged or substandard wiring.
- Do not disassemble the SunBank Series inverter. It contains no user-serviceable parts. See Warranty for instructions on obtaining service. Attempting to service the SunBank Series inverter yourself may result in a risk of electric shock or fire and will void your warranty.
- Keep away from flammable, explosive materials to avoid fire disaster.
- The installation place should be away from humid or corrosive substance.
- Authorized service personnel must use insulated tools when installing or working with this equipment.
- PV modules shall have an IEC 61730 class A rating.

● **PE Connection and leakage current**

- The end-use application shall monitoring of the protective conductor by residual current operated protective device (RCD) with rated fault current  $I_{fn} \leq 240\text{mA}$  which automatically disconnects the device in case of a fault.
  - DC differential currents are created (caused by insulation resistance and through capacities of the PV generator). In order to prevent unwanted triggering during operation, the rated residual current of the RCD has to be min 240mA.
- The device is intended to connect to a PV generator with a capacitance limit of approx 700nf.



**WARNING !**

High leakage current!  
Earth connection essential before connecting supply.

- Incorrect grounding can cause physical injury, death or equipment malfunction and increase electromagnetic.
- Make sure that grounding conductor is adequately sized as required by safety regulations.
- Do not connect the ground terminals of the unit in series in case of a multiple installation. This product can cause current with a d.c component, Where a residual current operated protective (PCD) or monitoring (RCM) device is used for protection in case of direct or indirect contact, only an RCD or RCM of type B is allowed on the supply side of this product.
- For Australia and New Zealand:  
The installation of inverter must fulfill Australia national Wiring rules AS/NZS3000, AS/NZS4777.1 and AS/NZS5033.



**WARNING !**

Do not work ! on the solar inverter when the device is running.

- Never touch either the positive or negative pole of PV connecting device. And never ever touch both at the same time.



**WARNING !**

Risk of electric shock!

- The unit contains capacitors that remain charged to a potentially lethal voltage after the MAINS and PV supply has been disconnected.
- Hazardous voltage will present for up to 5 minutes after disconnection from power supply.
- CAUTION-RISK of electric shock from energy stored in capacitor, never work on the solar inverter couplers. The MAINS cable, PV cables or the PV generator when power is applied. After switching off the PV power and Mains, always wait for 5 minutes to let the intermediate circuit capacitors discharge before you unplug DC input and MAINS couplers.
- When access to internal circuit of solar inverter, it is very important to wait 45 minutes before working on power circuit or demounting the electrolyte capacitors inside the device. Do not open the device before hand since the capacitors require this long to discharge sufficiently!
- Measure the voltage between terminals UDC+ and UDC with a multi-meter (impedance at least 1Mohm) to ensure that the device is discharged before beginning work (35VDC) inside the device.

## 2.4 EC Directives

This chapter follows the requirements of the European low voltage Directives, which contains the safety instructions and conditions of acceptability for the end user system, which you must follow when installing, operating and servicing the unit. If ignored, physical injury or death may follow, or damage may occur to the unit. Read this instructions before you work on the unit. If you are unable to understand the dangers, warnings, cautions or instructions, contact the manufacture if an authorized service dealer before installing. Operating and servicing the unit.

The Grid connected inverter meets the requirement stipulated in Low voltage Directive (LVD) 2006/95/EC and Electromagnetic compatibility (EMC) Directive 2004/108/EC. The unit is tested based on:

EN 50178:1997  
EN 62109-1:2010  
EN 62109-2:2011  
VDE 0126-1-1:2006  
VDE 4105:2011

In case of installation in PV system, startup of the unit (i.e. start of designated operation) is prohibited until it is determined that the full system meets the requirements stipulated in EC Directive (2006/95/EC,2004/108/EC, etc.)

The grid connected inverter leaves the factory completely connecting device and ready for connection to the mains and PV supply. The unit shall be installed in accordance with national wiring regulations. Compliance with safety regulations depends upon installing and configuring system correctly, including using the specified wirings. The system must be installed only by professional assemblers who are familiar with requirements for safety and EMC. The assembly is responsible for ensuring that the end system complies with all the relevant laws in the country where it is to be used.

The individual subassembly of the system shall be interconnected by means of the wiring methods outlined in national/international such as the national electric cod (NFPA) No.70 or VDE regulation 0107.

### 3 Introduction

#### 3.1 Basic Feature and Different Working Modes

The Sunbank storage series including Sunbank grid tied inverter, Sunbank grid tied storage inverter and charger modules. With all these function modules, you can design your own PV self-use storage system as you needed.

The self-use system need to be build with either a grid tied inverter, a charger module and a battery system or a grid tied storage inverter and a battery system. We have the below working modes for your home made energy storage system.

- **Self Use**  
In the "Self Use" mode the priority of the PV generated power will be : local load> battery> public grid. It means the PV generated power will be used in local load then the battery charging and the redundancy power will be delivered to the public grid.
- **Force Time Use**  
In the "Force Time Use" mode, user can set the charging and discharging time according to his wishes.

#### 3.2 Terminals of Grid Tied Storage Inverter, Grid Tied Inverter and Charger

Grid tied storage inverter (SK-SU)

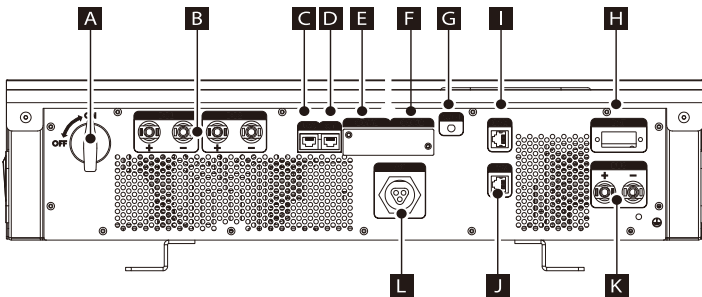

Grid tied inverter (SK-TL)

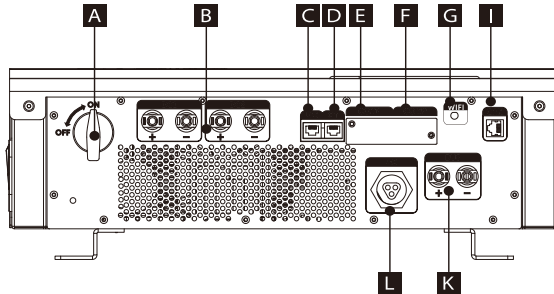

## Grid tied inverter (SK-BMU)

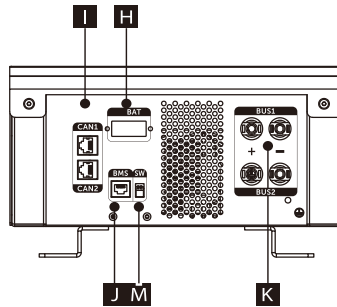

Object	Description
A	DC switch
B	DC connector area
C	Ethernet connector
D	Outside current sensor or meter port
E	Communication port for dry contact
F	Communication port for update
G	Wifi antenna connector
H	Battery connector
I	CAN communication port for external BMU
J	Battery communication port
K	BUS connector port for external BMU
L	AC connector
M	No. of battery group.

**WARNING !**

Only qualified electricians can operate the connection.

## 3.3 Dimension

## Dimension for SK-SU series

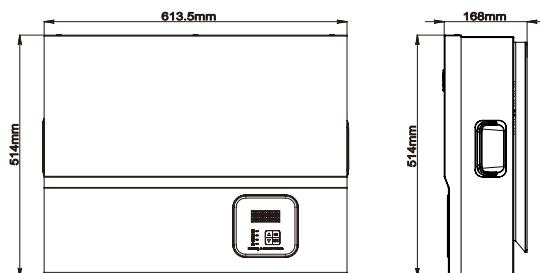



Dimension for SK-TL series

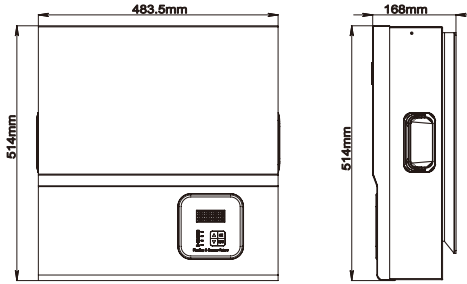

Dimension for SK-BMU series

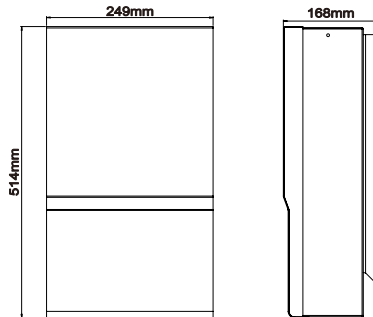

3.4 Identification of Sunbank

Model Name

Parameter

Series Number

Labels







**GRILL-CONNECTED PHOTOVOLTAIC INVERTER**  
**Model:SK-SU3000**

**SOLA X**

Max. DC voltage	550V
Rated input voltage	360V
MPP voltage range	125-530V
Max. DC current (input A/input B)	12 A/12 A
Absolute max. total PV array short circuit current(input A/input B)	15 A/15 A
Max. DC power (Ibco <sub>s</sub> =+1)	3300W
Nominal AC voltage	230V~
Nominal AC current	15A
Max. continuous AC current	16.6A
Nominal AC apparent power (Ibco <sub>s</sub> =+1)	3300VA
Nominal AC grid frequency	50 Hz
Battery type	Lithium or lead-acid
Battery Voltage	48V
Max. Charge current	25A
Max. Discharge current	25A
Power factor at rated power	1

Operating temperature range	0.95 over / 0.95 under	Std. zited
Operati ambient temperature range	-20 C ~50 C	
Ingress protection	IP20 (Inlet)	Self
Protect class	I	
Overvoltage category	III (MANS)	PVI
Grid monitoring	AS4777 / V1 (EN60439) / JOVE/ONC	AR-N 4105 / 61026-1-1-C138/11 / IER901-4-712

S/N: ●

**SolaX Power CO.,LTD**  
ADD: No.208 Shulin Road, Tonglu Economic Development Zone, Dongxing District, Tonglu City, Zhejiang Province, China.  
TEL: +86 571 5850 9576 E-mail: info@solaXpower.com  
[www.solaXpower.com](http://www.solaXpower.com) **MADE IN CHINA**

Manufacture Info

## 4 Technical Data

### 4.1 DC Input

Model	SK-TL(SU)3000	SK-TL(SU)3700	SK-TL(SU)5000
Max. DC input power (W)	3300	4000	5000
DC input Voltage range(V)	100-550	100-550	100-550
MPP voltage range(V)	125-530	125-530	125-530
Rated input voltage(V)	360	360	360
Start input voltage(V)	100	100	100
Max. DC input current per input (A)	12/12	12/12	12/12
Max. short-circuit current per input (A)	15/15	15/15	15/15
No. of MPP inputs	2	2	2
No. of strings per MPP input	1	1	1
DC Disconnection switch	Optional	Optional	Optional

### 4.2 AC Output

Model	SK-TL(SU)3000	SK-TL(SU)3700	SK-TL(SU)5000
Rated output power@ cosφ=1(W)	3000	3680	4600
Max. apparent AC power(VA)	3000	3680	4600
Rated grid voltage(V)	230	230	230
AC voltage range(V)	180~270	180~270	180~270
AC nominal current(A)	13	16	20
Max. output current(A)	14.4	16	22.1
Max. short-circuit current(A)	40	40	50
The harmonic factor if output Current at AC THD voltage<2% AC power>0.5 nominal AC power	<3%	<3%	<3%
Rated AC frequency(Hz)	50/60	50/60	50/60
Rated AC frequency range(Hz)	44-55/55-65	44-55/55-65	44-55/55-65
Max. inverter backfeed current to the array	500mA	500mA	500mA
Inrush current	60A	60A	60A
Maximum output fault current	150A	150A	150A
Maximum output overcurrent protection	25A	25A	25A
Displacement power factor, adjustable	0.95 overexcited...0.95 underexcited		
Feed in phase	Single-phase		
Over voltage category	III (electric supply side), II (PV side)		

### 4.3 Battery (for the SK-SU)

Model	SK-SU3000	SK-SU3700	SK-SU5000
<b>Battery</b>			
Battery voltage (V)	48		
Battery voltage range (V)	40-58		
Battery type	Lead-acid battery/lithium battery		
Battery capacity	100-120Ah optimized(support external expansion)		
<b>Battery charger</b>			
Rated power (W)	1300		
Max. charge current (A)	25		
Charge efficiency (%)	94		
Charging curve	3-stage adaptive with maintenance		
<b>Battery discharger</b>			
Rated output power (W)	1300		
Max. discharge current (A)	25		
Discharge efficiency (%)	94		
Discharge depth (%)	80% default		
Battery voltage sense	Yes		
Current shunt	Yes		

### 4.4 Efficiency, Safety and Protection

Model	SK-TL(SU)3000	SK-TL(SU)3700	SK-TL(SU)5000
Max. Efficiency	97.6%	97.6%	97.6%
Euro Efficiency	97.0%	97.0%	97.0%
MPPT Efficiency	99.9%	99.9%	99.9%
<b>Safety &amp; Protection</b>			
Over voltage/under voltage Protection	YES	YES	YES
DC isolation Impedance	YES	YES	YES
Monitoring Ground Fault Protection	YES	YES	YES
Grid Monitoring	YES	YES	YES
Ground Fault Current monitoring	YES	YES	YES
DC Injection Monitoring	YES	YES	YES
Back feed current monitoring	YES	YES	YES
Residual current detection	YES	YES	YES
Anti-island protection	YES	YES	YES
Over load protection	YES	YES	YES
Over heat protection	YES	YES	YES

## 4.5 General Data

Model	SK-TL(SU)3000	SK-TL(SU)3700	SK-TL(SU)5000
Dimension (W/H/D) (mm)	483.5×514×168 (613.5×514×168)		
Dimension of packing (W/H/D) (mm)	610 ×720 ×270 (740 × 720 × 270)		
Weight (kg)	23(27.7)		
Gross weight (kg)	29(34.7)		
Cooling concept	Forced airflow		
Noise emission	<40 dB		
Operating temperature range (°C)	-10~+50 (derating at 40)		
Store temperature (°C)	-20~+60		
Max.permissible relative humidity (non-condensing)	95%		
Pollution degree	II		
Altitude (Km)	<2000		
Degree of protection	IP20 (for indoor use)		
Topology	Transformer-less		
Internal consumption (W)	<3		
LCD display	Backlight 16*4 character		
Communication interface	Ethernet/Dry contact /wifi		
Standard Warranty	Standard 5 years		

## 5 Installation

### 5.1 Unpacking

Check the delivery for completeness. Contact your dealer at once if anything is missing.

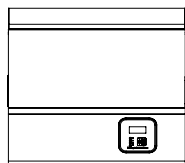

A

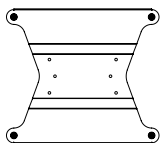

B



C



D

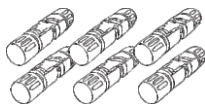

E

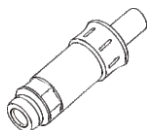

F



G

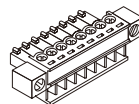

H

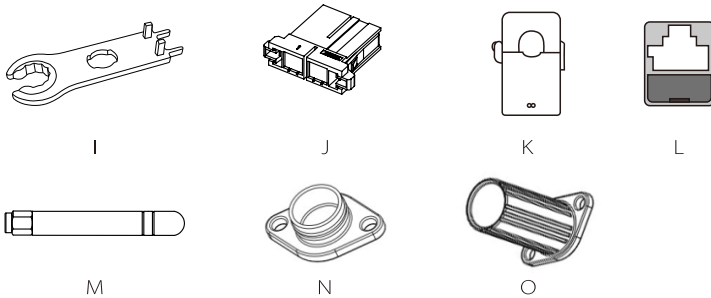

Object	Quantity	Description
A	1	Sunbank series inverter
B	1	Bracket
C	1	Warranty card
D	1	User manual
E	4	DC connectors 4 units (2* positive ,2* negative)
F	1	AC connector
G	1	Screw package 6*expansion screws 6*expansion tubes
H	1	8 pin terminal block male connector for dry connector.
I	1	Wrench tool for separate DC connector.
J	1	Battery connector .
K	1	Current sensor
L	1	RJ45 extend port
M	1	WIFI antenna
N	2	The stopper of the male DC connector
O	2	The stopper of the female DC connector

Open the package and pick the product, check that if there is any distortion or impaired during the transportation. Meanwhile, check that if the relating accessories and the materials are here, you can see the accessories list in the table.

The instruction manual is an integral part of the unit and should therefore be read and kept carefully.

It is recommended that the packaging should not be removed until the unit is located in the installation site.

## 5.2 Check for Transport Damage

Check if the SunBank series inverter has some visible external damage , such as cracks in the housing or display please contact with your dealer if you find any damage.

### 5.3 Installation Precaution

The SunBank series inverter is designed for indoor installation (IP20)  
Make sure the installation site does not fall into none of the following conditions:

- Do not install the inverter in direct sunlight.
- Do not install the inverter on flammable construction material.
- Do not install the inverter in areas where highly flammable materials are stored.
- Do not install the inverter in potentially explosive areas.
- Do not install the inverter during periods of precipitation or high humidity (>95%); Moisture trapped within the location may cause corrosion and damage to the electric components.
- Provide adequate ventilation when using batteries, and also read the warning label on the bottom of the inverter.
- Install the inverter in a location that maintains an ambient air temperature that is less than 40°C; That is to maintain a safe internal component temperature, the inverter would reduce power if the ambient air temperature exceeds 40°C.
- The inverter should be installed in a location that is not accessible for children.
- The inverter emits a slight vibrating noise when operating, which is normal and no effect on performance.
- The slope of the wall should be within  $\pm 5^\circ$ .
- The inverter is heavy, ensure the mounting place is strong enough to hold the weight of the inverter.
- If you install the inverter in a cabinet, closet or other small enclosed area, sufficient air circulation must be provided in order to dissipate the heat generated by the unit.

### Available Space Size

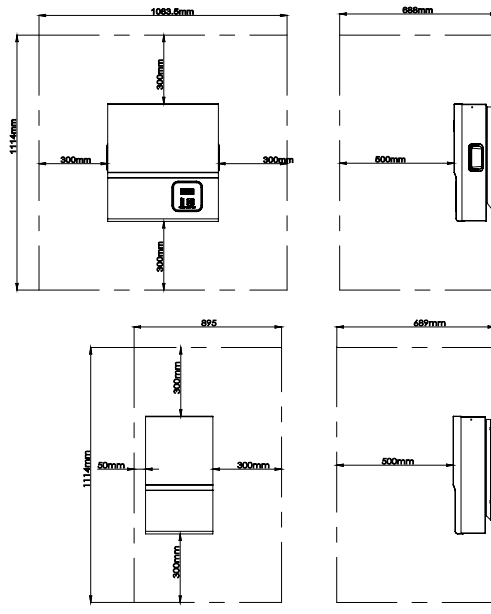



**WARNING!**

Before installation and maintenance, AC and DC side doesn't carry electricity, but if DC side is just disconnected, capacitance still contains electricity, so please wait for at least 5 minutes to ensure the capacitors completely release the energy and inverter is not electrified.



**NOTE !**

Inverters should be installed by technicians.

### 5.4 Preparation

Below tools are needed before installation.



**Installation Tools**

Installation Tools: crimping pliers for binding post and RJ45, screwdriver, manual wrench,  $\phi$  6 driller and rubber hammer.

### Lifting and Handling

The unit is heavy. Do not lift it alone.

- During lifting procedures ensure that the unit is firmly secured to avoid the risk of accidental tipping or dropping.
- Parts serving for support or immobilization of unit shall be designed and manufactured so as to minimize the risk of physical injuries and of accidental loosening of fixing.
- Ensure that the method of lifting will not allow the unit to slip from chains and slings or turn-over or slide from lifting devices.
- Transportation must be carried by specialized person (truck operators. Hook-up personal), equipped with the necessary protection equipments (overalls, safety shoes, protective gloves, helmets, goggles)
- Do not walk or stand beneath or in the proximity of the load.
- Avoid sudden movements and jolts when unloading and positioning the unit. Internal handling procedures must be conducted with care. Do not exert leverage on the components of the machine.
- If the unit is not balanced apply ballast. Any protruding parts should not be supported by hand.
- The inverter should be installed so that the operating panel shall be easily accessible- easy access to the electrical power connection point.
- Accessible for maintenance and repair work.
- Parts serving for support or immobilization of unit shall be designed and manufactured so as to minimize the risk of physical injuries and accidental loosening of fixings.

- Loading capacity and hardness of the supporting surface, load rating of mounting bracket should be at least four times the weight of the devices according to IEC62109-1. and supporting characteristics will be impaired by wear, corrosion, material fatigue or ageing. This should be calculated by inspection of the design data of supporting material and consulting construction engineer.

## 5.5 Installation Steps

### Step1: Screw the wall bracket on the wall

- Use the wall bracket as a template to mark the position of the six holes.
- Drill holes with  $\phi 8$  driller carefully, make sure the holes are deep enough for install and tight the expansion tubes.
- Install the expansion tubes in the wall, and screw the wall bracket using the screws in the screw package.

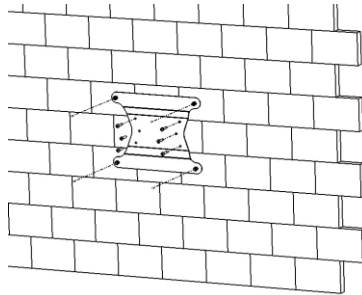

### Step2: Hang the Sunbank inverter on the wall bracket.

- Transport the inverter needs at least 2 people, each one needs to use the handles at the sides of the inverter.
- Hang the inverter onto the bracket, make sure the support in the bracket is fixed with the inverter.

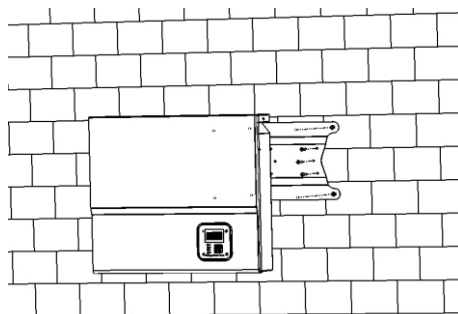



**Step3: Install the top cover of the inverter.**

- Put the top cover on the top of the inverter. Fix it well.
- Screw the Screw tightly on the both sides of the inverter.

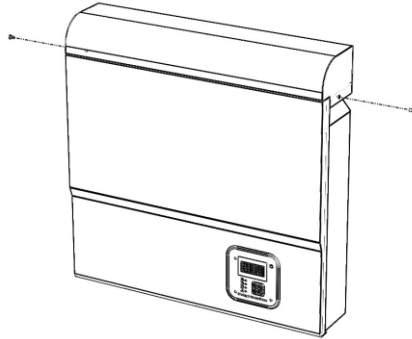

Note: The installation of SK-BMU is the same as above.

## 5.6 Connections of the PV Power System

### PV String



**WARNING!**

PV module voltage is very high which belongs to dangerous voltage range, please comply with electric safety rules when connecting.



**WARNING!**

When the photovoltaic array is exposed to light, it supplies a D.C voltage to the PCE.



**WARNING!**

When there is something wrong with the modules arrays. Modules can be connected with inverter only after eliminating these problems.

SunBank series inverters can be connected in series into 2-strings PV modules. Please select PV modules with excellent function and reliable quality. Open-circuit voltage of module arrays connected in series should be <Max. DC input voltage; Operating voltage should be conformed to MPPT voltage range.

**Table 3 Max. DC Voltage Limitation**

Model	SK-TL(SU)3000	SK-TL(SU)3700	SK-TL(SU)5000
Max. DC Voltage		550V	
MPPT voltage range		125-530V	



**NOTE!**

The following requirements of PV modules need to be applied for each input area;  
 • Same type • Same quantity • Identical alignment • Identical Tilt

Please use PV cable to connect modules to inverter. From junction box to inverter, voltage drop is about 1-2%. So we suggest the inverter install near PV module, in order to save cable and reduce DC loss. (No longer than 30m)



**NOTE!**

Please do not make PV positive or negative ground!

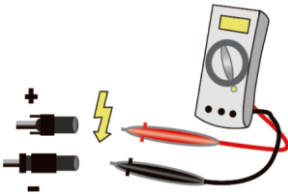

- Use multimeter to measure module array voltage
- Check the PV+ and PV- from the PV string combiner box correctly. Make sure the PV+ and PV- connected correctly.

**Connection Step:**

1. Disconnect the DC switch.
2. Choose the 12 AWG wire to connect the PV module.
3. Strip 6mm of insulation from the Wire end.



4. Separate the DC connector as below.

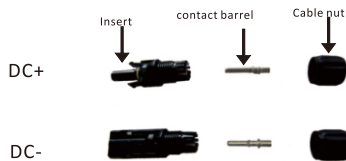

5. Insert striped cable into contact barrel and ensure all conductor strands are captured in the contact barrel.
6. Crimp contact barrel by using a crimping pliers. Put the contact barrel with striped cable into the corresponding crimping pliers and crimp the contact.



7. Insert contact cable assemble into back of the male or female insert. When you feel or head a "click" the contact cable assembly is seated correctly.



- 8. Tight the DC connector.
  - a. Slide the cable nut towards the back shell.
  - b. Rotate the cable nut to secure the cable.

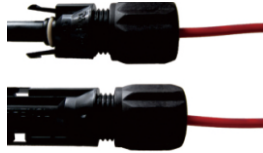

- 9. After secure the cable tightly, align the 2 half connectors and mate them together by hand until a “click” is felt or heard.



- 10. Separate the DC connector
  - a. Use the specified wrench tool.
  - b. When separate the DC+ connector, push the tool down from up side.
  - c. When separate the DC- connector, push the tool down from the bottom side.
  - d. Separate the connectors by hands.



**WARNING!**  
Before connecting, disconnecting the connection between solar generator and inverter and locked it to the open position during installation. Place a warning sign “do not turn on maintenance in progress” on the external disconnect switch when it is shut Down, and make sure that on-off remote controls are inhibited.

#### AC Output



**WARNING!**  
Must comply with the connection requirement of your distribution grid.

SunBank series inverters are designed for single phase grid. Voltage range is from 230V according to different countries. The typical frequency is 50Hz. Other technical requests should comply with the requirement of local public grid. For the terminal and cable design please follow below requirements.

**Terminal capacity and Identification.**

	Connection type	Rated connecting capacity and rating	Tightening torque	Stripping length
Protective earthing connection	Torx-head Screw(m5)	-----	1.8-2Nm	11mm
DC input connection	Amphenol(MC4)		1.8-2Nm	-----
AC output connection	Amphenol		1.8-2Nm	-----
RS485	Connector	-----	-----	-----

Earth conductor: PE screw terminal designed for clamping a cable lug or bar by means of a screw, nut and locking washer, before PE connection, strip the conductor end 12mm long to fit them into a cable lug or bar. For PE connection, the length of conductors between the cord anchorage and the terminal, shall be such that the current-carrying conductors became taut before the earthing conductor if the cable slips out of the cord anchorage.

Model	SK-TL(SU)3000	SK-TL(SU)3700	SK-TL(SU)5000
Cable(Cu)	4-5mm <sup>2</sup>	4-5mm <sup>2</sup>	5mm <sup>2</sup>
Micro-Breaker	20A	20A	25A



**WARNING!**

Make sure you select the correct specification cables for installation. Otherwise the power will make the cable hot or burnt, it could result in death or serious injury

**Connection Step:**

1. Check the grid voltage and compare with the permissible voltage range. (see technical data).
2. Disconnect the circuit-breaker from all the phases and secure against re-connection.
3. Disconnect the AC connector from the inverter.
4. Separate the AC plug into three parts as below.

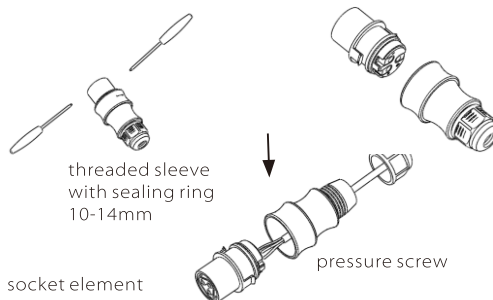

4. Put the threaded sleeve and the pressure screw through the AC wire.

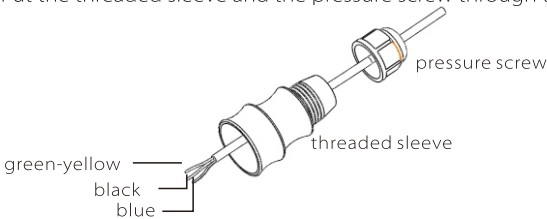

5. Wire the AC wire refer to below instructions.
- a. Screw the green-yellow wire to the ground terminator in the AC connector.
  - b. Screw the blue wire to the N(neutral) terminator in the AC connector.
  - c. Screw the black or brown wire to the L (line) terminator in the AC connector.

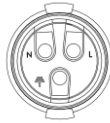

6. Confirm all the wires are screwed down.

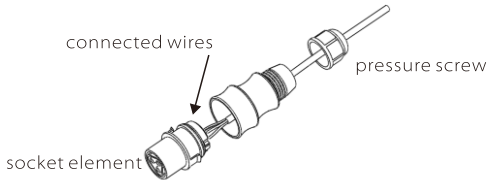

7. Screw down the threaded sleeve.

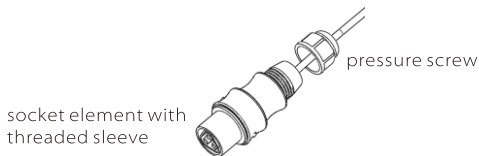

8. Screw down the pressure screw.

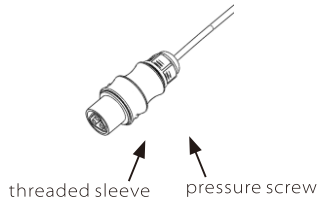

### Selection of Fuse and Cables

Mains cable (AC line cable ) shall be short circuit protected and thermal overload protected.

Always fit the input cable with fuse. Normal gG(US:CC or T) fuses will protect the input cable in short circuit situation. They will also prevent damage to adjoining equipment.

Dimension the fuses according to local safety regulations, appropriate input voltage and the related current of the solar inverter.

AC output protected by external fuse (gG rated current 20A/250VAC for 3KW and 3.7KW; 25A/250VAC for 5KW) provide in all live connections to the AC supply. The rated short circuit breaking capacity of the above protective device shall be at least equal to the prospective fault current at the point of installation. See section technical data of this manual for details.

Ac output cable: Cu, L, N+PE, 2\*5 .0+5.0mm<sup>2</sup> @40°C ambient with a max length of 5m , with operating time of the fuse is less than 5 seconds, installation method B2 according to EN60204-1:2006, annex D: cable in conduit cable trunking system, number of loaded circuit only one . Use H07RNF (cord designation 60245 IEC66) for an ambient temperature between 40°C and 60°C.

**Note 1:** For conditions differing from those mentioned above ,dimension the cables according to local safety regulations, appropriate input voltage and the load and the load current of the unit.(You can choose a thicker cable but the fuses must rated according to the cable.)

**Note 2:** Fuses must be approved by Notified Body.

Inverter is not provided galvanic isolation from the mains to the PV array, backfeed current to the array is 20A/250VAC for 3KW and 3.7KW; 25A/250VAC for 5KW, based on the fuse provided in the mains. Also in the worst case .the reverse current comprises the sum of the short-circuit currents of all intact lines.

There for the current-carrying capacity of the components and sub-assemblies provided in the end-use system(connectors ,cables, junction box, switch ger,etc.) and the reverse current PV module shall be considered based on the backfeed current and reverse current. The direct current (DC) circuit breaker or fuse between each solar generator and inverter shall be provided based on solar inverter input ratings.

Select DC cables based on the above inverter back-feed current and I<sub>sc</sub> PV rating and V<sub>max</sub> ratings.

## ● Battery connection (for SK-SU series)

When you want to build a self-use storage system , the battery is a necessary part. The Sunbank SK-SU series inverter provide the necessary part of the interfaces to connect the battery to the inverter.



### **WARNING!**

Make sure you select the correct specification cables for installation. Otherwise the Power will make the cable hot or burnt, it could result in death or series injury.

### ① The power connection between the battery and the inverter.

1. Connect one side of the battery connect wire to the inverter.
2. Fit a fuse (30A slow blow) in the both positive and negative battery cable as close as possible to the battery.

3. Connect the positive side of the battery connect wire to the positive side of the battery , the negative side of the battery connect wire to the negative side of the battery.
4. Make sure the positive and negative of the battery is correct.

② The communication connection between the battery and the inverter.

Communication

The communication interface between battery and inverter is RS232 or CAN using a RJ45 connector. The Pin definition is as below.

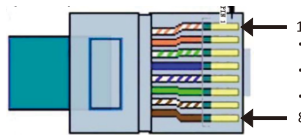

Pin	1	2	3	4	5	6	7	8
Function	CANH	CANL	GND	RS232_TXD	RS232_RXD	GND	X	X

Connection steps

1. Prepare RJ45 connectors and a communication cable.
2. Strip the insulation from the communication cable.
3. Insert the communication cable into the RJ45 connector following the PIN definition rule.
4. Crimp the RJ45 connector with the crimping plier.
5. Insert RJ45 side of the cable into the LAN connector on the inverter and connector the other side to the battery.

**Note: The battery communication can only work when the battery BMS is compatible with the inverter.**

● Battery Manager connection( Please refer to section 9)

① The power connection between the inverter and the battery manger.

There is power cable in the accessory package of the charger if you bought a battery manager . Connect the cable with the inverter and manager.

② The communication connection between the inverter and the Battery manager

There is a communication cable in the accessory package of the manager if you bought a battery manager. Connect the cable with the inverter and manager.

● Current sensor connection

The current sensor measure the current on the phase wire that runs between the inverter and the grid. This enables the inverter to determine the Power requirements of the connected consumer. The current sensor is connected to the CT port on the inverter. The current sensor is a necessary part of the inverter. Please do not forget to connect or an error will occur.

Connection Step:

1. Insert the RJ45 terminal on the current sensor into the CT port on the inverter.
2. Place the current sensor around the phase wire L to which the inverter is connected.
3. Place the current sensor around the phase wire L to measure the Current going to or coming from the grid.
4. Make sure the current sensor is installed in the right direction: The arrow on the current sensor must point to the Public grid.

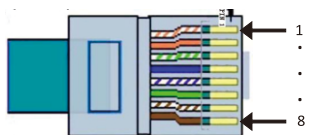
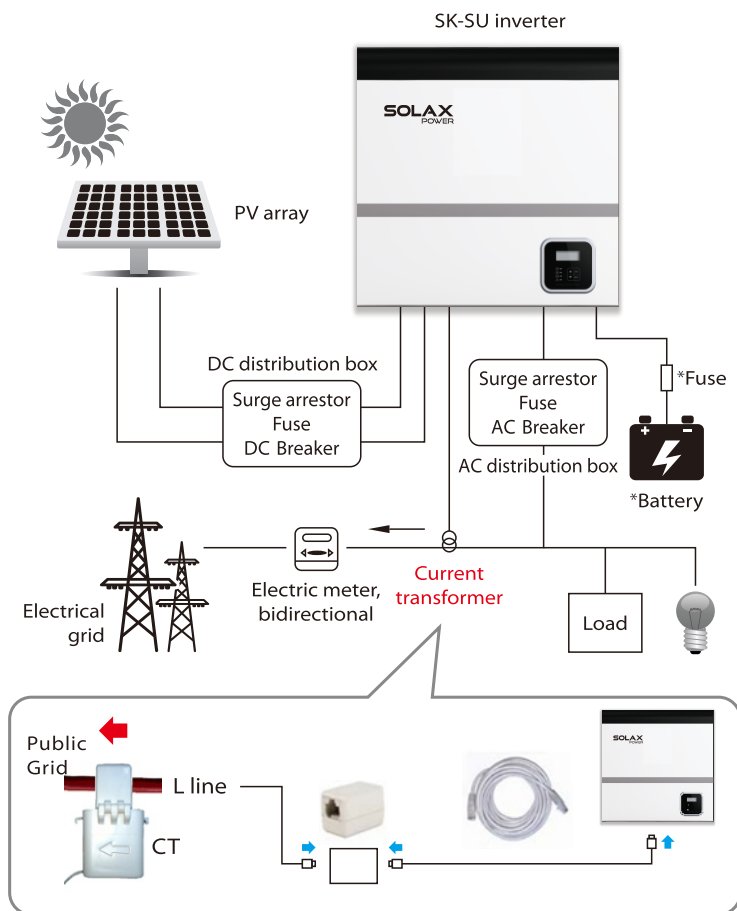

When connect the RJ45 connector with the wire of the CT or Meter , please follow the below sequence :

Pin	1	2	3	4	5	6	7	8
CT	Red wire	X	X	X	X	X	X	Green wire
Meter	X	X	X	Blue wire	White wire	X	X	X





**NOTE!**

- Do not place the sensor on the N Wire or the earth wire.
- Do not place the sensor on the N and L wire simultaneously.
- Do not place the sensor on the L wire going to the consumer.
- Do not place the sensor with the arrow pointing to the generation meter.
- Do not place the sensor on the non-insulated wires.
- Do not place the on a phase other than the one connected to the inverter.
- Do not use the wire over 25m.



**NOTE!**

- The sensor can be upgraded to meter.
- With a one phase meter provided by SolaX can monitoring the 24hr usage of electric.
- With a three phase meter provided by SolaX can implement three phase compensation.

**●Connection the earth of the enclosure.**

You can additionally earth the inverter enclosure of a second earthing or equipotential bonding is required locally. This prevents touch current if the original protective conductor fails.

Cable size: 12AWG.

Connection step:

1. Strip the earthing cable insulation.
2. Insert the stripped cable into the ring terminal.
3. Clamp the end of the ring terminal.
4. Unscrew the screw of the earthing connector.
5. Suit the ring terminal on the earthing connector .Suit the gasket on the earthing connector.

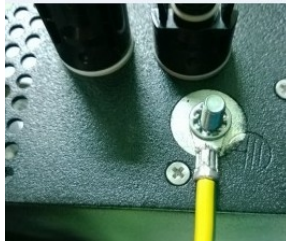

6. Screw the the screw of the earthing connector.



## ● Communication interface

This product has a series communication interfaces: such as LAN, Wifi (optional), Dry contact and Extend port and for human and machine communication. Operating information like output voltage, current, frequency, fault information, etc., can be delivered to PC or other monitoring equipment via these interfaces.

### ① LAN

#### ● Communication

LAN communication is one standard communication interface. It transmits the data between the router and SUNBANK series inverters in the local area network. User can set the parameters with specialized software provided by SolaX. The pin definition of the connector as below.

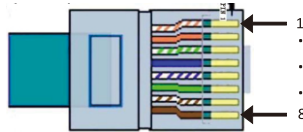

Pin	1	2	3	4	5	6	7	8
Function	TPTX+	TPTX-	2.5V	GND	GND	2.5V	TPTX+	TPTX-

#### ● Connection steps

1. Prepare two RJ45 connectors and a communication cable.
2. Strip the insulation from the communication cable.
3. Insert the communication cable into the RJ45 connector following the PIN definition rule.
4. Crimp the RJ45 connector with the crimping plier.
5. Repeat the above steps to fix the other head of the communication cable.
6. Insert one side of the cable into the LAN connector on the inverter, and the other side of the cable into the router.

### ② Wifi Communication

#### ● Communication

Wifi communication interface is another standard interface, you can check the detail from the internet either from PC or smartphone.

- Connections and setting please refer to the wifi setting Guide.

### Dry contact

#### • Communication

Dry contact is provided to give a remote monitor and remote control with the optional accessory. The remote monitor function provides an indication on the inverter's working status. The remote control function provides a contact signal to operate the inverter. The dry contact communication use terminal blocks. The PIN definitions and the circuit connection are as below.

Pin	1	2	3	4	5	6	7	8
Definition	Remote control for reactive power regulation						Remote monitor	

Note: The external connection of PIN7 and PIN 8 must within the range of 300V 2A.

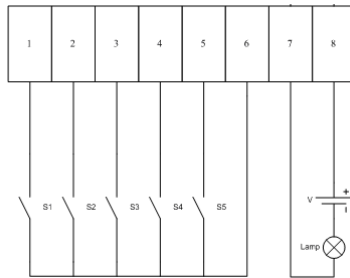

#### • Connection steps

1. Choose at least 1mm<sup>2</sup> wire. Trip the insulation from the wire ends.
2. Insert the tripped wire into the hole of the terminal block.
3. Screw down the screws on the terminal block.

### 5.7 Run the inverter

**Start inverter after checking all below steps:**

- Check that the device is fixed well on the wall.
- Make sure all the DC wirings and the AC wirings are completed.
- Make sure the CT is connected well.
- Make sure the battery is connected correctly.
- Turn on the external AC and DC connector.
- Turn on the DC switch to the "ON" position.

**Start inverter**

- Inverter will start automatically when the PV panel generate enough energy or the battery is charged.
- Check the status of LED and LCD screen, the LED should be green and the LCD screen should display the main interface.
- If the LED is not green, please check the below:
  - All the connections are right.
  - All the external disconnect switches are closed.
  - The DC switch of the inverter is in the "ON" position.
- Enter the setting interface.
- Set the safety standard as page35.
- Set the system time as page 36.
- PV connection mode as page 36 .
- Set the work mode as page 38
- Set charger as page 39.
- Set the ethernet or WIFI as the WIFI setting guide.



**WARNING!**

Power to the unit must be turned on only after installation work has been completed. All electrical connections must be carried out by qualified personnel in accordance with legislation in force in the country concerned.



**NOTE !**

Please set the inverter if it is the first time to start up. Above steps is for the regular start up of the inverter. If it is the first time to start up the inverter, you need to setup the inverter .

## 6 Operation Method

### 6.1 Control Panel

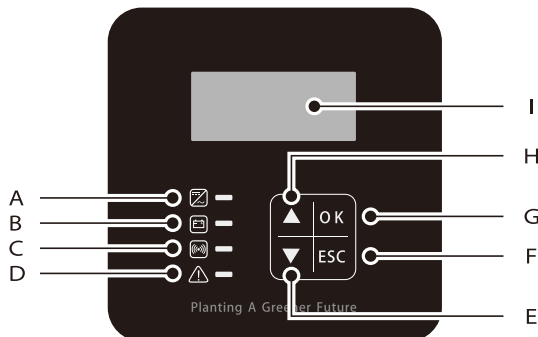

Object	Name	Description
A	Indicator LED	Green: Normal working status.
B		Blue: Battery charging or discharging.
C		Yellow: Communication status.
D		Red: Error.
E	Function Button	Down button: Move cursor to downside or decrease value.
F		ESC button: Leave from current interface or function.
G		OK button: Confirm the selection.
H		Up button: Move cursor to upside or increase value.
I	LCD Screen	Display the information of the inverter.

## 6.2 LCD Function

### Menu structure

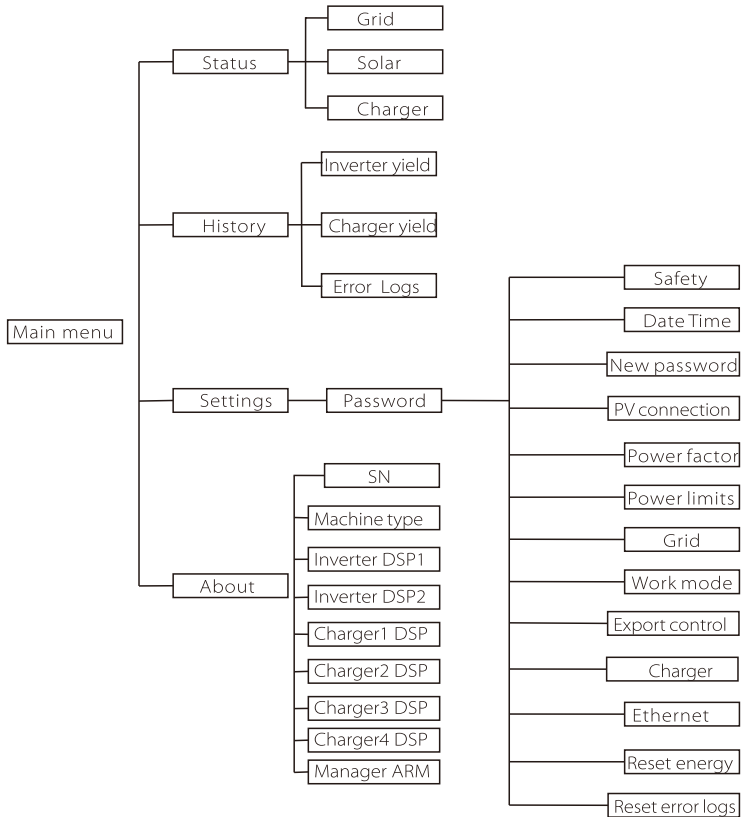

### 6.3 LCD Operation

- LCD Digital Display

The main interface is the default interface, and the inverter will automatically jump to this interface when the system started up successfully or not operated for a period of time.

The information of the interface is as below. The "Power" means the timely output power; "Today" means the power generated within the day. "Battery" means the left percentage of battery energy. "Normal" show the status of the inverter.

Power	0W
Today	0.0KWh
Battery	%
Normal	

- Main interface

The main interface is a transfer interface for user to get into the other interface to finish the setting or to get the information.

- User can get into this interface by pressing the "OK" button when the LCD displays the main interface.
- User can select interface by moving the cursor with the function button, and press "OK" to confirm.

MENU	
Status	
History	
Settings	

- Status

The status function contains three aspects of the inverter, the grid , solar and the battery.

Press up and down to select and press "OK" to confirm the selection, press "Esc" to return to the Menu.

Status	
Grid	
Solar	
Charger	

A) Grid status

This status shows the current grid condition such as voltage, current, output power and the local consumed power . Pout measures the output of the inverter, Pgrid measures the export or import to or from the grid.

Press up and down button to review the parameter. Press "Esc" to return to Status .

Grid	
U	000.0V
I	00.0A
P	00.0W

B) Solar status

This status shows the current PV condition of the system. The input voltage, current and power situation of every PV input.

Press up and down button to review the parameter. Press "Esc" to return to Status .

Solar	
U1	360.0V
I1	1.0A
P1	360W

C) Charger status

This status shows the charger situation of the system. Include the battery voltage, charge or recharge current. Charge or recharge power, battery capacity and battery temperature. It can show 4 groups of battery. "+" means in charging; "-" means in discharging. Press up and down button to review the parameter.

Press "back" to return to Status.

Charger	
U1	54.0V
I1	+1.0A
P1	+54W

- History

The history function contains three aspects of the information: Yield, consume and error log.

Press up and down to select ,and press "OK" to confirm the selection, press "Esc" to return to the Menu.

History
Inverter Yield
Charger Yield
Error Logs

D) Inverter Yield

The inverter yield function contains the energy generated by today, yesterday, this month, last month and total. Press up and down button to review the parameter. Press "Esc" to return to history .

Inverter Yield
>Today:
00.0KWH

E) Charger Yield

The charger Yield function contains the energy generated from battery today, yesterday, this month, last month and total.

Press up and down button to review the parameter. Press "Esc" to return to history .

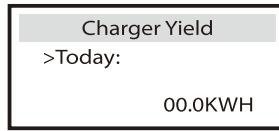

F) Error logs

The Error log contains the error information happened, Which can record for three items.

Press up and down button to review the parameter. Press "back" to return to History .



• Settings

Setting function is used for setting the inverter for time, connection, battery, Ethernet, Grid and so on.

Since this function will change the inverter's parameter, We need password to enter.

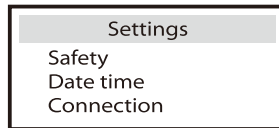

G) Password

The default password is "0000" for end user, Which only allow the user to review the current setting. if any change is needed , please contact with the distributor or factory for the installer password. we need to increase or decreased the word by press up or down button. Press "OK" to confirm and alternate to the next word. After all when the word is confirmed. Press "OK" to enter the password.

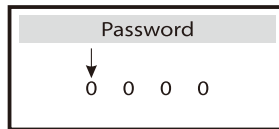

H) Safety

The user can set the safety standard here. According to different country and grid tied standard. There is 8 standard for choice.( May change without notice)

Item	1	2	3	4	5	6	7	8
Standard	VDE0126	EN50438_DK	EN50438_NL	E8001	C10/C11	G83	AS4777	ARN4105
Country	German	Danmark	Netherland	Austria	Belgium	England	Australia	German





I) Date time

This interface is for user to set the system date and time. Increase or decrease the word by press up or down button. Press OK to confirm and alternate to the next word. After all the word are confirmed. Press "OK" to enter the date and time.

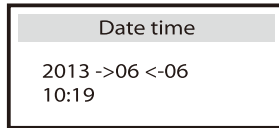

J) New Password

Installer can set the new password here. We need to increase or decreased the word by press up or down button. Press "OK" to confirm and alternate to the next word. After all the words are confirmed. Press "OK" to reset the password.



K) PV Connection

This function can set the mode of PV input. There are two modes for choice: Comm and Multi. The "Comm" mode mean single MPP tracking ,2 MPPT working together; "Multi" means multi-MPP tracking, 2 MPPT working independently. Press up or down button to select and press "OK" to confirm.

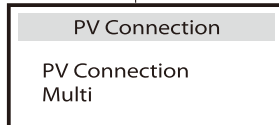

L) Power factor( For specific country if required by the local grid)

User can set the power factor here. There is 4 modes for select: OFF, Ind, Cap, Curve.

Select "off" to shut off this function; Select "Ind" to set the inductive power factor; Select "Cap" to set the capacitive power factor ; Select "Curve" to set the power factor including "upper limit", "Lower limit"; "power upper" and "power lower" according to below curve. All the setting can set the parameter from 0.00 to 1.00.

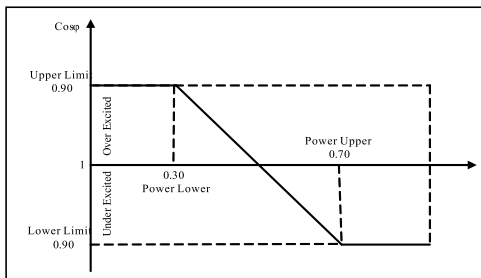

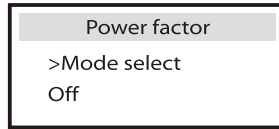

M) Power limit

User can set the output power limitation of the inverter here, the setting value is from 0.00-1.00.

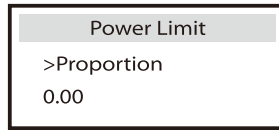

N) Grid

Usually user do not need to set the parameters here, as when you select the safety the default value will be used according to the safety rules. The parameters here is described as below. If need to reset, please contact with your installer. Any changes should according to the requirement of the local grid. Press up or down button to select and press "OK" to confirm.

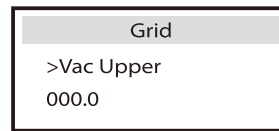

Parameter	Comment
Vac upper	Voltage high protect
Vac lower	Voltage low protect
Vac upper slow	Voltage high slow protect
Vac lower slow	Voltage low slow protect
Fac upper	Frequency high Protect
Fac lower	Frequency low protect
Fac upper slow	Frequency high slow protect
Fac lower slow	Frequency high slow protect
Vac 10m avg	10 min voltage high protect

O) Work mode

The default work mode of the inverter is Self Use mode. User can setting the work mode as Self Use or Force Time Use here as describe in 3.1.

For the Force Time Use. User can set 2 periods of the start and end time of charger or discharge. Also can select if charging from grid for each charging period.

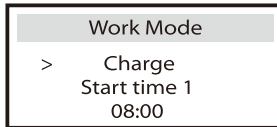
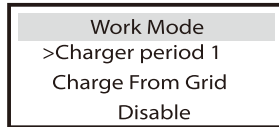
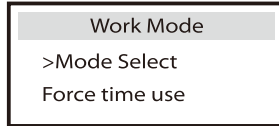

Parameter	Comment
Charger start time1	The start time of the first charger period.
Charger end time1	The end time of the first charger period.
Charger start time2	The start time of the second charger period.
Charger end time2	The end time of the second charger period.
Discharger start time1	The start time of the first discharger period.
Discharger end time1	The end time of the first discharger period.
Discharger start time2	The start time of the second discharger period.
Discharger end time2	The end time of the second discharger period.

P) Export control

With this function the inverter can control the energy exported to the grid.

There is user value and factory value. The factory value is default which can not be changed by user, the value setting by the installer must be less than the factory value and within the range of the CT as 5KW or the meter as 13KW.

Press up or down button to select and press "OK" to confirm.



Q) Charger

The inverter is compatible with Lead acid and lithium batteries, and can support up to 4 external BMU. Users can set the battery type, charge and discharge parameters here.

Press up or down button to select and press“OK” to confirm.

For the detailed parameters , please refer to below table.

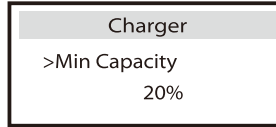
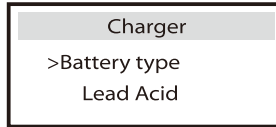
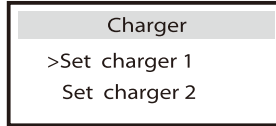

Parameter	Comment
Min capacity	The remaining capacity of the battery, refer to the DOD of the battery as suggested by the supplier.
Charge cut voltage	When the battery voltage reached this value , the BMU will stop to charge the battery.
Discharge cut voltage	When the battery voltage reached this value , the BMU will stop to discharge the battery.
Charge max current	The charge current can be set for 0-25A. The charge power can also be set.
Discharge max current	The discharge current can be set for 0-25A. The charger power can also be set.

**Note: The “Min capacity” is only available when the battery have communication with the BMU.**

R) Ethernet

Users can set the information about Ethernet here , such as IP address, subnet mask number, and default gateway number. Press up or down button to select and press "OK" to confirm.

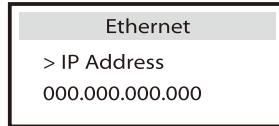

S) Reset energy

User can reset the energy record here. Press up or down button to select and press "OK" to confirm.

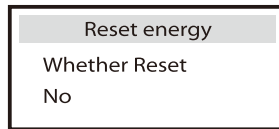

T) Reset error logs

User can reset the error log here. Press up or down button to select and press "OK" to confirm.

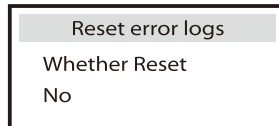

• About

This interface shows the information of the inverter , Such as series numbers, and software version.

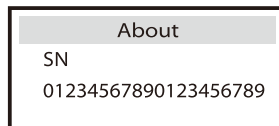

# 7 Troubleshooting

## 7.1 Trouble Shooting

This section contains information and procedures for solving possible problems with the SUNBANK series inverters, and provides you with trouble shooting tips to identify and solve most problems that could occur with the SUNBANK series inverters.

This section will help you narrow down the source of any problem you may encounter. Please read the following troubleshooting steps.

- Check the warning or fault messages on the System Control Panel or Fault codes on the inverter information panel. If a message is displayed, record it before doing anything further.
- Attempt the solution indicated in below table.

Faults	Diagnosis and solution
SPI Fault	SPI communication fault <ul style="list-style-type: none"> <li>• Disconnect PV+ , PV- and battery, reconnect them.</li> <li>• Or seek help from us, if can not go back to normal state.</li> </ul>
SCI Fault	SCI communication fault <ul style="list-style-type: none"> <li>• Disconnect PV+ , PV- and battery, reconnect them.</li> <li>• Or seek help from us, if can not go back to normal state.</li> </ul>
CAN1 Fault	CAN communication fault <ul style="list-style-type: none"> <li>• Disconnect PV+ , PV- and battery, reconnect them.</li> <li>• Or seek help from us, if can not go back to normal state.</li> </ul>
PV Config Fault	PV Connection Setting Fault <ul style="list-style-type: none"> <li>• Resetting the PV connection</li> <li>• Or seek help from us, if can not go back to normal state.</li> </ul>
Inv EEPROM Fault	Inverter EEPROM fault <ul style="list-style-type: none"> <li>• Disconnect PV+ , PV- and battery, reconnect them.</li> <li>• Or seek help from us, if can not go back to normal state.</li> </ul>
Relay Fault	Relay Fault <ul style="list-style-type: none"> <li>• Disconnect PV+ , PV- and battery, reconnect them.</li> <li>• Or seek help from us, if can not go back to normal state.</li> </ul>
Sample Fault	The detection circuit Fault <ul style="list-style-type: none"> <li>• Disconnect PV+ , PV- and battery, reconnect them.</li> <li>• Or seek help from us, if can not go back to normal state.</li> </ul>
RCD Fault	Residual Current Device Fault <ul style="list-style-type: none"> <li>• Check the impedance of DC input and AC output.</li> <li>• Disconnect PV+ , PV- and battery, reconnect them.</li> <li>• Or seek help from us, if can not go back to normal state.</li> </ul>
Fan1 Fault	Fan Device Fault <ul style="list-style-type: none"> <li>• Disconnect PV+ , PV- and battery, reconnect them.</li> <li>• Check if the fan is stopped by dust or other foreign.</li> <li>• Or seek help from us, if can not go back to normal state.</li> </ul>
Fan2 Fault	

Faults	Diagnosis and solution
AC HCT Fault	AC Current sensor Fault <ul style="list-style-type: none"> <li>• Disconnect PV+ , PV- and battery, reconnect them.</li> <li>• Or seek help from us, if can not go back to normal state.</li> </ul>
DC1 HCT Fault	DC Current sensor Fault <ul style="list-style-type: none"> <li>• Disconnect PV+ , PV- and battery, reconnect them.</li> </ul>
DC2 HCT Fault	<ul style="list-style-type: none"> <li>• Or seek help from us, if can not go back to normal state.</li> </ul>
DCI Fault	DCI Device Fault <ul style="list-style-type: none"> <li>• Disconnect PV+ , PV- and battery, reconnect them.</li> <li>• Or seek help from us, if can not go back to normal state.</li> </ul>
TZ Protect Fault	Over current fault. <ul style="list-style-type: none"> <li>• Wait for a while to check if go back to normal status.</li> <li>• Disconnect PV+ , PV- and battery, reconnect them.</li> <li>• Or seek help from us, if can not go back to normal state.</li> </ul>
Grid Lost Fault	Grid is lost. <ul style="list-style-type: none"> <li>• System will reconnect if the utility is back to normal.</li> <li>• Or seek help from us.</li> </ul>
Grid Volt Fault	Grid Voltage out of range <ul style="list-style-type: none"> <li>• System will reconnect if the utility is back to normal.</li> <li>• Or seek help from us.</li> </ul>
Grid Freq Fault	Grid Voltage out of range <ul style="list-style-type: none"> <li>• System will reconnect if the utility is back to normal.</li> <li>• Or seek help from us.</li> </ul>
PLL Lost Fault	The grid is not good. <ul style="list-style-type: none"> <li>• System will reconnect if the utility is back to normal.</li> <li>• Or seek help from us.</li> </ul>
Bus Volt Fault	Bus Voltage out of normal range. <ul style="list-style-type: none"> <li>• Disconnect PV+ , PV- and battery, reconnect them.</li> <li>• Check if the PV input is within the range of the inverter.</li> <li>• Or seek help from us, if can not go back to normal state.</li> </ul>
AC5M Volt Fault	The grid's Voltage is out of range for the last 5 Minutes. <ul style="list-style-type: none"> <li>• The system will back to normal if the grid is back</li> <li>• Or seek for help from us.</li> </ul>
Inv OCP Fault	Inverter over current protection Fault <ul style="list-style-type: none"> <li>• Wait for a while to check if back to normal.</li> <li>• Or seek for help from us.</li> </ul>
DCI OCP Fault	DCI over current protection Fault. <ul style="list-style-type: none"> <li>• Wait for a while to check if back to normal.</li> <li>• Or seek for help from us.</li> </ul>
RC Fault	DCI over current protection Fault. <ul style="list-style-type: none"> <li>• Wait for a while to check if back to normal.</li> <li>• Or seek for help from us.</li> </ul>

Faults	Diagnosis and solution
PV Volt Fault	PV Voltage Fault <ul style="list-style-type: none"> <li>• Check the output of the PV voltage.</li> <li>• Or seek for help from us.</li> </ul>
AC10M Volt Fault	The grid's Voltage is out of range for the last 10 Minutes. <ul style="list-style-type: none"> <li>• The system will back to normal if the grid is back</li> <li>• Or seek for help from us.</li> </ul>
Isolation Fault	Isolation Fault <ul style="list-style-type: none"> <li>• Check the connection of the inverter.</li> <li>• Or seek for help from us.</li> </ul>
Temp Over Fault	Temperature Over the limitation <ul style="list-style-type: none"> <li>• Check if the fan is running normally.</li> <li>• Check if the envirement temperature is over limitation.\</li> <li>• Or seek help from us.</li> </ul>
Fan1 Speed Fault	Fan Speed out of the normal range. <ul style="list-style-type: none"> <li>• Check if the fan is stopped by dust or other foreign.</li> </ul>
Fan2 Speed Fault	<ul style="list-style-type: none"> <li>• Or seek help from us, if can not go back to normal state.</li> </ul>
C1 -C5 Can Fault	The battery group's Can communication Fault. <ul style="list-style-type: none"> <li>• Reconnect the charger communication cable.</li> <li>• Or seek help from us.</li> </ul>
C1-C5 Temp High	The battery charger is over temperature. <ul style="list-style-type: none"> <li>• Check if the air ducting of the charger is blocked.</li> <li>• Improve the working environment or reduce the charging or discharging current.</li> <li>• Or, Seek help from us.</li> </ul>
C1-C5 FAN Fault	The Fan of the charger is broken. <ul style="list-style-type: none"> <li>• Check if the fan is working normally.</li> <li>• Check if anything blocking the fan</li> <li>• Or, Seek help from us.</li> </ul>
C1-C5 TZ Fault	The protection of the charger fault. <ul style="list-style-type: none"> <li>• Wait for a while to check if back to normal.</li> <li>• Or, Seek help from us.</li> </ul>
C-C5 EEPROM Fault	The charger's EEPROM fault. <ul style="list-style-type: none"> <li>• Wait for a while to check if back to normal.</li> <li>• Or, Seek for help from us.</li> </ul>
C1-C5 HCT Fault	The charger's current detection fault. <ul style="list-style-type: none"> <li>• Reconnect the charger.</li> <li>• Or, Seek for help from us.</li> </ul>
C1- C5 Bus OVP	The Bus voltage of the charger over limit. <ul style="list-style-type: none"> <li>• Wait for a while to check if back to normal.</li> <li>• Or, Seek for help from us.</li> </ul>
C1-C5 Temp Low	The charger is under temperature <ul style="list-style-type: none"> <li>• Improve the working environment of the charger.</li> <li>• Or, Seek for help from us.</li> </ul>



Faults	Diagnosis and solution
C1-C5 Boost OVP	The Boost voltage of the charger over limit. • Wait for a while to check if back to normal. • Or. Seek for help from us.
C1-C5 Bat OVP	The battery voltage is over limit. • Wait for a while to check if back to normal. • Or, Seek for help from us.
C1- C5 Charger OCP	The charger is over current protected. • Wait for a while to check if back to normal. • Or, Seek help from us.
C1-C5 Boost OCP	The boost current of the charger is over limit. • Wait for a while to check if back to normal. • Or, Seek help from us.
CT Fault	The CT or the meter is not connected well. • Check the connection of the CT or the meter. • Or, Seek help from us.

If your inverter's information panel is not displaying a Fault light, check the following list to make sure that the present state of the installation allows proper operation of the unit.

- Is the inverter located in a clean, dry, and adequately ventilated place?
- Have the DC input breakers been opened?
- Are the cables adequately sized and short enough?
- Are the input and output connections and wiring in good condition?
- Are the configurations settings correct for your particular installation?
- Are the display panel and the communications cable properly connected and undamaged?

Contact SolaX Customer Service for further assistance. Please be prepared to describe details of your system installation and provide the model and serial number of the unit.

## 7.2 Routine Maintenance

### ● Inverter

Inverters need to be checked every 12 months . (once per year)  
 Clean the housing with a dry cloth and check that there is no airflow obstruction. Remove any dust build-up from the locations as indicated. Check the inverter and the cables for visible external damage on regular basis.



#### **WARNING!**

Clean the airflow holes inside the housing, and cut off the power from the inverter by decommissioning or by using a bypass switch. Internal cleaning is only to be carried out by certified persons. Contact your installer/dealer if you find any defects. Do not perform any repair work by yourself.

- **Battery**

The SUNBANK series inverter compatible with both lead-acid and lithium battery. Either type of the battery needs to be maintained every month /quarter/ year according to different types and requirement of the battery.

If the capacity of the battery decreased to lower than 80% of the rated capacity, the battery should be replaced.

**NOTE !**

The chapter is only for reference. The exact maintenance should be according to the guilds provided by the battery manufacture.

## 8 Decommissioning

### 8.1 Dismantling the Inverter

- Disconnect the inverter from DC Input and AC output.
- Disconnect battery wirings.
- Wait for 5 minutes for de-energizing.
- Disconnect communication and optional connection wirings.
- Remove the inverter from the bracket.

### 8.2 Packaging

If possible, please pack the inverter with the original packaging.

If it is no longer available, you can also use an equivalent carton that meets the following requirements.

- Suitable for loads more than 25 kg.
- With handle.
- Can be fully closed.

### 8.3 Storage

Store the inverter in dry place where ambient temperatures are always between -20 °C - +60 °C.

### 8.4 Disposal

When the inverter or other related components need to be disposed. Have it carried out according to local waste handling regulations. Please be sure to deliver wasted inverters and packing materials to certain site, where can assist relevant department to dispose and recycle.

## 9 Battery Manager

### 9.1 Introduction

The Sunbank battery manager can be used with SK-TL or SK-SU series inverter for extending the battery capability of self use, Max to 4 battery manager for one inverter (including the internal one for SK-SU series)

### 9.2 Technical Data

Model	SK-BM1300
<b>Battery</b>	
Battery voltage (V)	48
Battery voltage range (V)	40-58
Battery type	Lead-acid battery/lithium battery
Battery capacity	100-120Ah optimized(support external expansion)
<b>Battery charger</b>	
Rated power (W)	1300
Max. charge current (A)	25
Charge efficiency (%)	94
Charging curve	3-stage adaptive with maintenance
<b>Battery discharger</b>	
Rated output power (W)	1300
Max. discharge current (A)	25
Discharge efficiency (%)	94
Discharge depth (%)	80% default
Battery voltage sense	Yes
Current shunt	Yes
<b>General data</b>	
Dimension (W/H/D) (mm)	295x514x168
Dimension of packing (W/H/D) (mm)	420x720x270
Weight (kg)	12.4
Gross weight (kg)	16.25
Cooling concept	Forced airflow
Noise emission	<40 dB
Operating temperature range (°C)	-20~+50 (derating at 40)
Store temperature (°C)	-20~+60
Altitude (Km)	<2000
Degree of protection	IP20 (for indoor use)

### 9.3 Connecting

- Connect the SK-SU with the SK-BMU

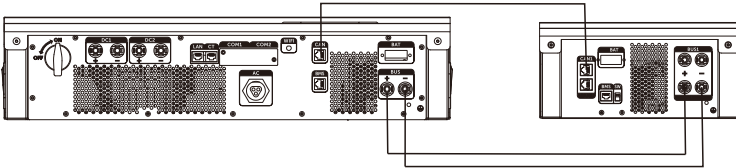

- Connect the SK-TL with the SK-BMU

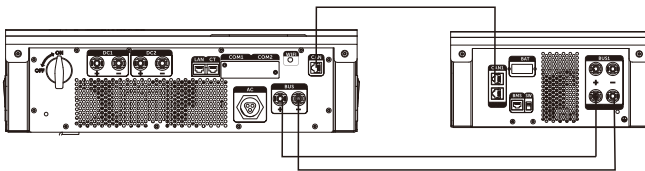

- Expand the SK-BMU

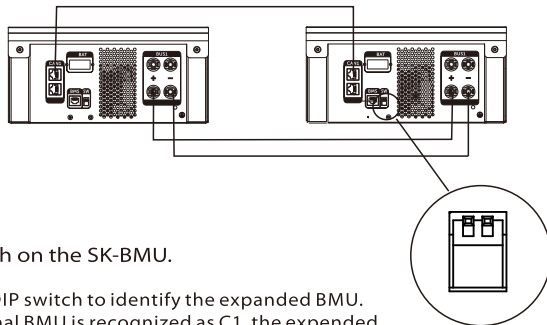

- Set the DIP switch on the SK-BMU.

We need to set the DIP switch to identify the expanded BMU.  
 For SK-SU, the internal BMU is recognized as C1, the expanded  
 BMU is recognized from C2-C4.

For SK-TL, the expanded BMU begins from C2, and the last should be set as C1.

DIP switch means "0" when on the up position;  
 means "1" when on the low position.

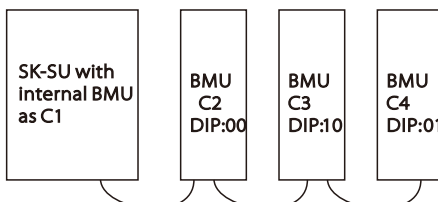

**Note:** For SK-SU, the expanded BMU can not set as C1(DIP:11) which can not be recognized.

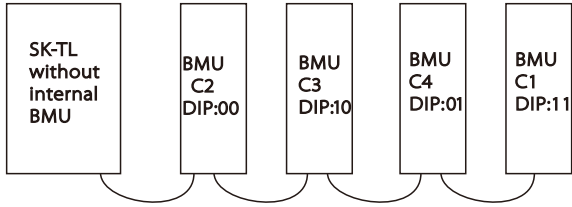



## SolaX Power Co., Ltd.

---

No.288 Shizhu Road, Tonglu Economic Development Zone,  
Tonglu City, Zhejiang province, China.

Tel: +86 0571-58509376

E-mail: [info@solaxpower.com](mailto:info@solaxpower.com)

[www.solaxpower.com](http://www.solaxpower.com)

614.00020.02