

# Installation and Operating Instructions



Manufactured with  
sustainable energy



[www.heckert-solar.com](http://www.heckert-solar.com)

09/2017



**Heckert Solar**  
energy meets quality

## **Installation and Operating Instructions**

These instructions are intended for the use of dealers and fitters engaged in the design, installation and operation of photovoltaic (PV) systems consisting of high performance polycrystalline or monocrystalline solar modules from the range supplied by Heckert Solar GmbH. They are designed to ensure that the concerned PV system achieves optimum yields throughout its working life. Installation in a way that is not compliant to this manual might void warranty.

Heckert Solar modules may only be installed by properly qualified specialists. Please observe the relevant norms and standards applying to photovoltaic installations, including – for example – VDE regulations, DIN standard specifications, VDEW guidelines and TAB (Technical Connection Requirements) standards (or local equivalent) of the corresponding mains network operator, along with the relevant health and safety and accident-prevention measures, especially IEC 62446 for starting and maintenance. Failure to comply with these stipulations may result in grave personal injury or serious damage to systems and equipment. The indications contained in these installation and operating instructions are based on current German legislation and industrial standards.

Keep these instructions filed as part of the technical documentation along with all the other documents supplied with the system. These documents should be available to the operator of the plant at any time.

Heckert Solar reserves the right to amend this document at any time without prior notice. Please use the latest version. You can find it on our homepage

<http://www.heckertsolar.com/de/downloads/partner-download-center/montage.html>.

These installation and operating instructions conform to the stipulations of TÜV Rhineland IEC 61730-1:2016.

### Overview

1. Hazard warnings and safety instructions
2. General information regarding PV systems
3. Delivery and handling of modules
4. Information regarding the module
5. Module installation
6. Connection and hook-up of modules
7. Return and recycling
8. Product/performance guarantee
9. Exclusion of liability

### 1: Hazard warnings and safety instructions

Solar modules generate electricity as soon as they are exposed to light. Voltage of 30 volts and more constitutes a danger in the event of physical contact. The connection, in series or parallel, of various modules increases the voltage and current accordingly. Note that the arrangement in series of more than two solar modules can result in voltages that are potentially fatal.



### **CAUTION: Danger of fatal electric shock!**

The plug-in contacts are fully insulated to prevent them being touched. You should, however, take the following precautions when handling the solar modules:

- Do not insert electrically conductive items into the pin-type or sleeve connectors.
- Do not install solar modules or wire conduits if their pin-type/sleeve connectors are wet.
- All work on wires and cables must be carried out with the utmost care and attention.
- Beware of the high contact voltages present in the power inverter, even when it is in an idle state.
- Exercise great care when carrying out work of any kind on the power inverter and/or its wiring system.

Heckert Solar modules comply with Class II.



## **CAUTION: Danger of fatal injury due to arcing!**

The opening of a completed live circuit (e.g. disconnection of the DC lead from the power inverter while under load) can result in fatal injury due to arcing.

- NEVER disconnect the solar generator from the power inverter while it is still connected to the network!

### **Working on the roof**

Please follow the official accident prevention regulation. Do not install the modules during high winds. Installation workers and objects on the installation site should be secured against falling off of the roof by appropriate measures. Securing of the work space to prevent injury of other persons is advised.

## 2: General information regarding PV systems

### **Alignment**

The solar module should be positioned southbound as near as possible (or northbound when installed on the southern hemisphere), in order to ensure optimum energy yield. The optimum angle of inclination can be calculated using the following formula:

$$\text{Angle of inclination} = \text{degree of latitude of installation site} - 20^\circ.$$

Deviations from the optimal orientation and inclination of the modules lead to reduced yield.

### **Place of installation**

The planned site of installation should be as free as possible of obstacles that are likely to create shade (e.g. other buildings, trees, chimneys, dormer windows, TV aerials, satellite dishes, overhead power lines, etc.), as these items can significantly reduce the performance of solar modules. Even partial shadows can result in considerable reductions in output. A module is considered shade-free if sunlight can fall on its entire surface all year round, with at least a minimal amount of light able to fall on it unhindered even at unfavourable, less sunny times of the year.

### **Rear ventilation**

The output of solar modules is considerably reduced when heated up. This applies in particular to our Black Edition units, which come with a black back sheet foil and a black frame. Rear-face ventilation helps prevent these performance-reducing build-ups of heat. Ensure also that there are no nearby items – such as skylights, glazed roofs, etc. – that are likely to spoil the “chimney-draught” effect that this system of ventilation relies on.

### **Winter**

The solar modules should be positioned in such a manner that as little snow as possible clings on them during winter. A short distance with respect to the eaves and a roof inclination of  $<20^\circ$  are both likely to lead to accumulations of snow on the bottom row of modules. Check the openings in the hollow profile sections of the module frame, and keep the corners free of dirt, so that condensation water can drain off freely.

### **Cleaning/maintenance**

With a sufficient inclination of the modules ( $>15^\circ$ ), cleaning is generally not required (self-cleaning by rain/snow). However, ambient conditions can have a strong influence on the soiling of modules, which should be checked at yearly intervals for accumulations of dirt. If the modules do become soiled, they should be cleaned when cool (e.g. during the early morning), using plenty of lukewarm, deionized water and a soft scouring pad. DO NOT use sharp, abrasive or pointed implements of any kind to clean the surface as they might scratch the module’s surface or damage the antireflective (AR) coating. Modules with AR glass should be cleaned by using plenty of lukewarm, demineralised water and clean, lint-free cotton, microfiber or paper towels. Greasy or oily residues can be removed with alcohol or a mixture of alcohol and water. The following should all be avoided: strong acids, caustic solutions, petrol-based cleaners, steam or heat-based cleaners, cleaning agents containing silicon oils, fluorides or waxes, polishes, alkaline cleaners, cleaners containing scouring agents and high pressure cleaners. All methods and means that replace  $\text{Na}^+$  ions in the glass surface are unsuitable for the cleaning of glass. All abrasive cleaning agents and utensils are equally unsuitable for this purpose. Please note that sudden, extreme changes in temperature can create tension strain in the glass, resulting in irreparable damage to the module.



**CAUTION: When carrying out cleaning and maintenance work, take care to ensure that the earth (ground) connection is not broken or damaged.**

### 3: Delivery and handling of modules

Check the delivery on arrival to ensure that all items are complete and undamaged. Heckert Solar will only recognise transit damage if it has been recorded on the driver's delivery note and reported immediately in writing.

Our modules are normally delivered in an upright position on a non-returnable pallet, each pallet carrying 27 or up to 18 modules, respectively. Unpacking, transport and interim storage should therefore be carried out with utmost care. Leave the modules in their packaging until you intend to install them. Pallets should always be placed on solid and levelled ground. DO NOT stack one pallet on top of another.



**The packaging is not foil-wrapped and therefore not rain-resistant!**



**CAUTION: Carefully follow the unpacking instructions printed on the packaging material. DO NOT remove the rear retaining belt at this stage.**

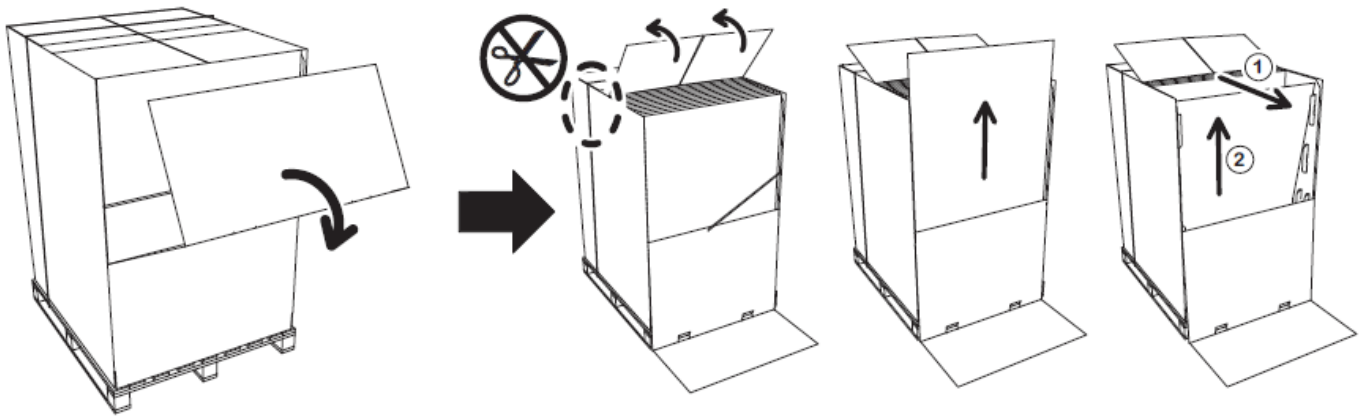

Fig. 1: Palette with 27 modules

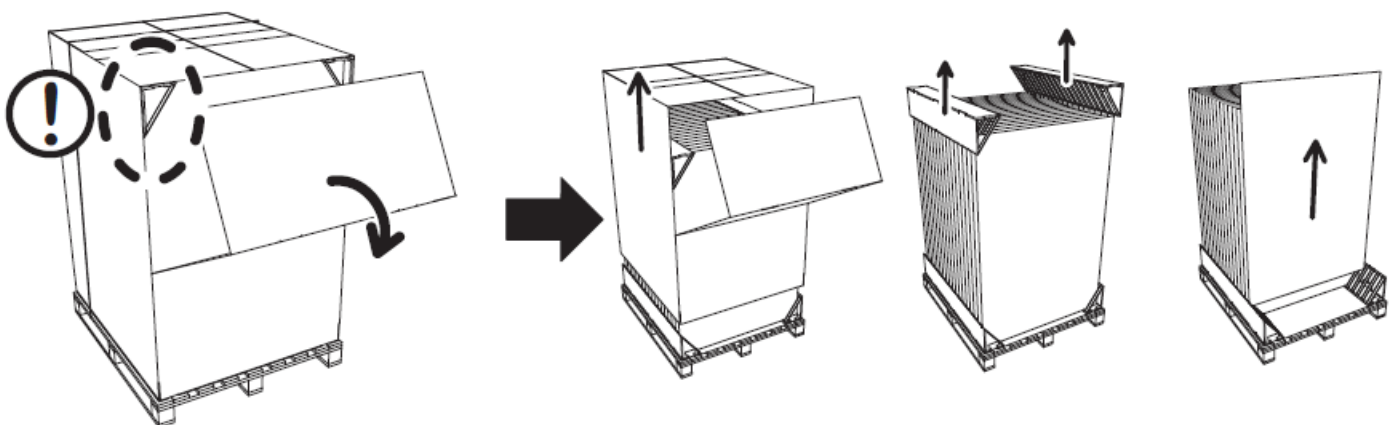

Fig. 2: Palette with 18 modules or less



**CAUTION: Handle the modules with great care!**

- Always lift and carry the modules using both hands. Do **not** use the connection box or cable to lift the module. Do not apply pressure or tension to the connection box or cable during transportation or installation (See Fig. 4).
- Do not expose the modules to extreme vibrations. Lower the modules gently when placing them on a hard surface. Do not stand the modules on their corners. When stacking one module on top of another, always place a layer of protective material in between. DO NOT place objects of any kind on top of the modules. **NEVER stand on the modules.** Do not drop the modules. Do not handle them with hard or pointed implements of any kind.
- The modules should be connected with great care, without using force. Keep all electrical contacts clean and dry.
- If you need to store the modules temporarily, ensure that they are kept in a dry, well-ventilated room.
- In order to keep a proper record of fitting, you should note down the serial number on the system layout plan kept at the place of installation.
- Do not install modules with damage



**CAUTION: Carefully follow the special information on the handling of modules with AR glass**

The surface of the AR-glass has a resistance to mechanical or chemical influences comparable with non-coated modules. Therefore they should be treated with the same degree of carefulness. Due to the special reflective properties slight contamination is, however, better visible. In particular, greases and oils in small amounts are already visible and can influence transmission. In order to avoid these marks, the modules should be handled with care already during unpacking and assembly and the surface of the modules should be touched exclusively using clean gloves.

#### 4: Information regarding the module

##### **Certification, Performance data**

For details of the performance specifications of our modules please refer to the data sheets of the corresponding series.

##### **Usage**

Please take the following factors carefully into account when using our modules:

- The installation or operation of the solar modules is limited to a maximum of max. 2000m above sea level.
- The function of the modules is tested at an ambient temperature of -40 to + 40 ° C. This area should be respected.
- The solar module is not compatible with seawater (recommended distance: 500 metres from the sea).
- The module should not be exposed to extreme chemical contamination (e.g. harmful emissions from industrial premises).
- Do not immerse the solar module in liquids or fluids of any kind.
- Do not use lenses or mirrors to concentrate the prevailing light (danger of overheating).
- Avoid damaging the module through hard-metal and diamond-edged objects.
- Protect solar modules from voltage surges (such as those produced by battery chargers, generators, etc.). If in doubt, please contact your specialist dealer.
- When connecting solar modules to storage batteries, be sure to observe the safety precautions specified by the battery manufacturer.
- Keep children away from the solar modules.

The closer the site of installation is to the equator, the more likely it becomes that the currents and voltages present can exceed those generated by a PV module under standard test conditions. You should therefore multiply the module's indicated  $I_{sc}$  and  $U_{os}$  values by a factor of 1.25, when determining the voltage ratings of components, current ratings of conductors and sizes of fuse for connection at the PV-module outputs. The maximum measured rating for overcurrent protection (reverse-current resistance) is 20 A.

## 5. Module installation

### General notes on module mounting

All modules can be arranged horizontally as well as vertically, independently of the position of the connection box.

The modules are to be mounted stress-free. The modules do not serve as a bend-resistant connecting or fastening element.

### Load on the modules

The load capacity of the standard solar modules depends on the installation situation and the mounting system used. Please take note of the following mounting options and the corresponding design loads which serves as the maximum allowed load during operation.

The modules were tested with a 1.5x higher load in accordance to the testing algorithm specified in IEC 61215: 2016.

### Standard situation with continuous mounting rails

Please note that the module can bend at high loads and lay down on the mounting rails. Ensure that the mounting rail is sufficiently stable and sufficiently supported by a frequent fixation at the underlying roof structure to prevent the mounting rail from bending. (tested with Heckert Solar rail and a support distance of max. 1m)

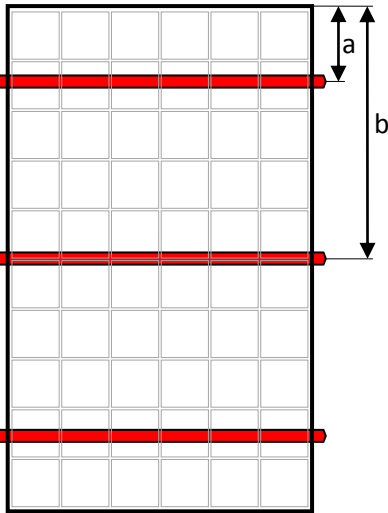
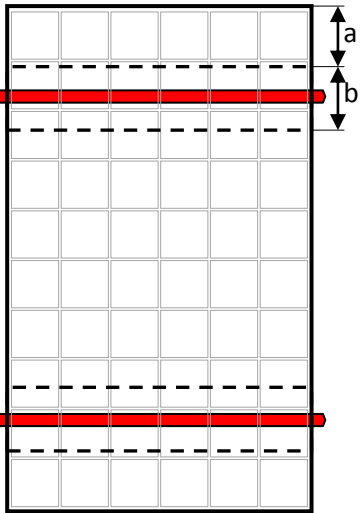
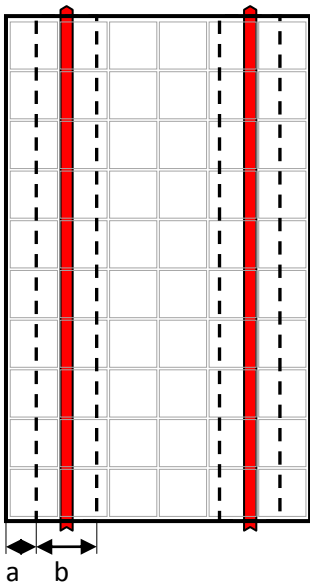
<p>Load pressure <b>5400 Pa</b> suction <b>1600 Pa</b></p>  <p>a = 250mm; b = 835mm 6 mounting points</p>	<p>Load pressure <b>3600 Pa</b> suction <b>1600 Pa</b></p>  <p>a = 250; b = 210mm 4 mounting points</p>	<p>Load pressure <b>3600 Pa</b> suction <b>1600 Pa</b></p>  <p>a = 100mm; b = 200mm 4 mounting points</p>
--	--	--

**Standard situation without continuous mounting rails**

Load pressure **1600 Pa**  
suction **1600 Pa**

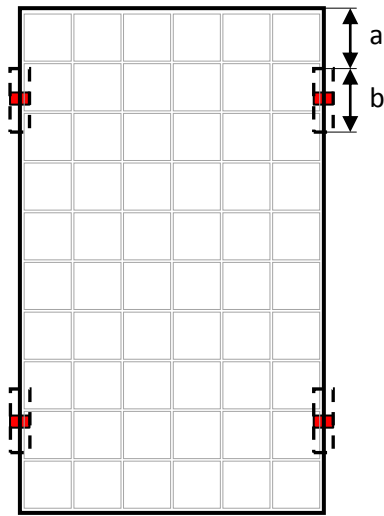

a = 200mm; b = 210mm  
4 mounting points

Load pressure **1600 Pa**  
suction **1600 Pa**

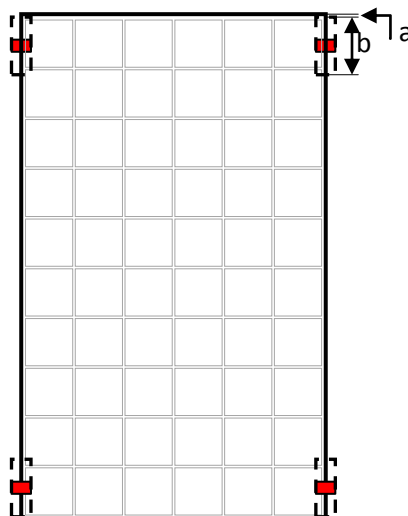

a = 10mm; b = 200mm  
4 mounting points

Load pressure **1600 Pa**  
suction **1600 Pa**

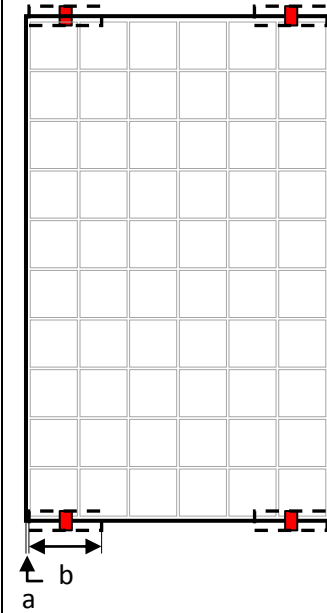

a = 10mm; b = 200mm  
4 mounting points

**Suspended ceiling systems**

Load pressure **2400 Pa**  
suction **1600 Pa**

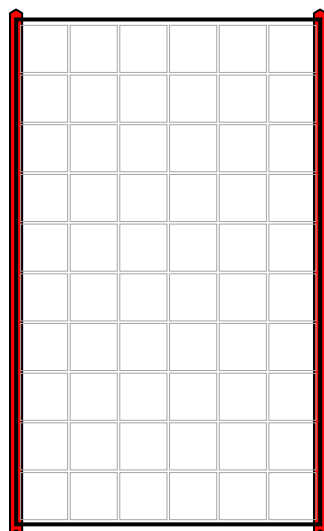

Linear bearing long side

Load pressure **3600 Pa**  
suction **1600 Pa**

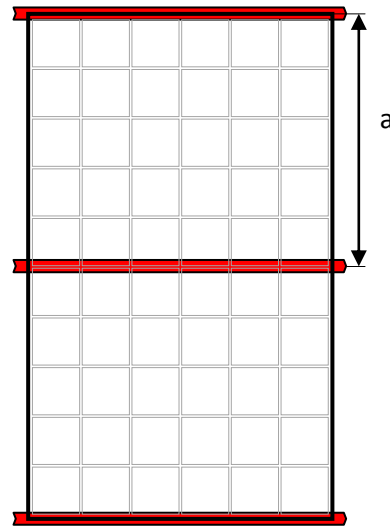

a = 835mm  
Linear bearing short side +  
continuous track

Load pressure **1600Pa**  
suction **1600Pa**

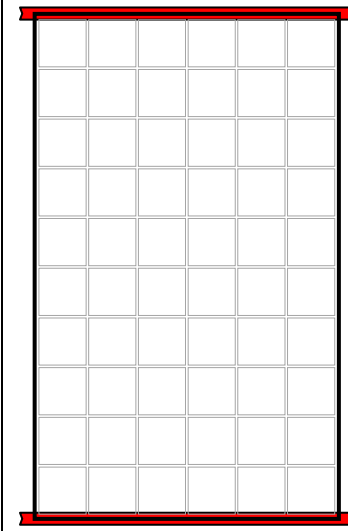

Linear bearing short side



**The maximum load capacity of the modules is only achieved with clamping in the specified range and compliance with all specifications!**

Ensure that the maximum mechanical load capacity is observed, paying particular attention to the load factors present at the site of installation (such as those resulting from wind and snow, etc. see also DIN 1055-4/5).

Do not use any material that may result in the module being exposed to, and therefore damaged by, sharp or pointed edges, or uneven structures. The snow load at base sk (measured in kN/m<sup>2</sup>) is calculated using local levels of snowfall, the location of the building and its height above sea level. The likely wind load for the site of the project should be estimated using a wind-zone chart that along with wind zones also takes into account local conditions. A simplified procedure can be used to estimate prevailing wind-load when considering buildings of up to 25 metres in height. Depending on the height of the building, wind-load is expressed as velocity pressure q, measured in kN/m<sup>2</sup>.





**CAUTION: Please note that the specialist firm engaged to fit the system is solely responsible for the planning and implementation of the project, and that a separate set of structural static calculations may have to be drawn up in certain cases.**

### Slip off safeguard

To prevent slipping of the modules on an inclined plane during assembly and to facilitate assembly, our module frames are provided with holes for anti-slip protection. In these holes allen screws can be installed that act as a stopper in case the modules slide down on the mounting system. The screws are secured with a washer and nut or with a self-locking nut. For the anti-slip device a screw M5x10 VA and the associated serrated washer and nut are recommended.

### 6: Connection and hook-up of modules

- The modules are wired directly via the plug socket fitted to the connection box (Fig. 3: Left-hand pin connector (+); right-hand pin connector (-)), for instance using the cable supplied with the module. Make sure that the connector locks into place with a clearly audible “click”.
- The unit is supplied ready-fitted with a cable on the positive (left-hand) side of the connection box. This cable is fitted with the corresponding positive (+) and negative (-) sleeve connectors. The connectors are keyed to prevent errors in the wiring of the installation.
- For the connection to the socket, only the use of the corresponding socket connectors by “TE connectivity” are permitted. Using other connectors voids warranty.

Sleeve connector	Code	Wire Gauge	Items-number	External diameter cable	
				5,5 – 8,0 mm	4,5 – 6,0 mm
	Plus	4,0	TE Heckert Solar	0-1394462-3 4021400000024	4-1394462-8 4021400000001
	Plus	6,0	TE Heckert Solar	5-1394462-5 4021400000005	
	Minus	4,0	TE Heckert Solar	1394461-4 4021400000026	4-13944662-9 4021400000003
	Minus	6,0	TE Heckert Solar	5-1394462-6 4021400000007	

- Crimping of the connectors can only be done with the original “TE connectivity” tool. Defective crimp connections can lead to considerable damage to the modules or even fire.
- The TE connectors may only be connected directly to the junction box. An inter-wire connection is not certified. The string cables must therefore be equipped with the TE female connectors. The first / last cable in the string is not needed.
- Alternatively, the unused cable can be cut in half. The free ends can then be equipped with any kind of PV connectors. Please make sure to connect only connectors of the same type and manufacturer. Mixing compatible connectors from different manufacturers is not permitted.





Pin connector (+)

Pin connector (-)

Sleeve connector (-)

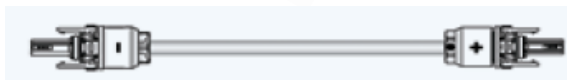

Sleeve connector

Fig. 3: Connection box and cable

- **DO NOT** pull on the connection cable itself when unplugging it (see Fig. 4).
- Pay attention to the requirements set out in DIN VDE 0298-3 regarding cable installation. In particular, note the information on minimum bending radius, standards for the attachment of cables and on how to install them.
- Plug-in connectors comply with the ingress protection class IP67, and sockets with IP65. Both components are therefore permanently protected from dust.
- Please pay careful attention to the instructions supplied by Tyco (enclosed at the end of this installation manual).



**CAUTION: Each manipulation of the connection box can lead to a loss of warranty and may only be undertaken by trained personnel!**



**CAUTION: Ensure that the cables are free of tension and properly crimped and connected to the plug!**



Fig. 4: Do not pull on the cable.

If various strings are in use, we recommend sorting the modules by their respective current at maximum power point ( $I_{MPP}$ ). This will help ensure maximum system output, as the weakest module determines the performance of the string as a whole.



**CAUTION: DO NOT install modules that are damaged in any way!**

### Wiring layout

Each string requires two cables for connecting the solar generator to the power inverter. We recommend the use of special solar cable conforming to standard EN 50618, Class 5 for this purpose. It should have a minimum cross-section of 4 mm<sup>2</sup>. Cable losses should be <1%. The cross-section of the cable should be adjusted accordingly to minimise loss over larger distances. Be sure to follow the cable laying standards specified in DIN VDE 0298-3.

Please note that both string cables must be plugged directly into the socket of the first / last module. A cable-cable-connection with TE connectors is not certified.



**Ensure that pin- and sleeve-type connectors are correctly mated!**

The strings (+ and - leads) are routed to the power inverter and connected to its DC inputs. The module plugs should be marked accordingly. The two strings (+ and -) should be laid together to prevent the forming of conductor loops.

It is vital to ensure the right polarity of the strings when connecting them to the inverter. Please make sure not to interchange the + and - cables. Check the individual strings for correct polarity and verify their voltages before connecting them to the power inverter.

The solar cables must be fitted to the power inverter using only suitably-certified, compatible plug-in connectors. Installation and/or connection of the power inverter(s) should be carried out in accordance with the manufacturer's instructions.



**IMPORTANT: Various string-lengths are possible, depending on module output and the type of power inverter used. Please ensure that the maximum system voltage is not exceeded even at low temperatures without load ( $V_{oc}$ ).**

### **Parallel connection of PV modules**

Please note that a 16A fuse protection is required when connecting more than two strings of our modules in parallel. This may be exceeded in the event of a defect occurring, if more than two strings are connected in parallel. The maximum reverse-current load is 20A.

### **Electrical installation**

Connection of the power inverter to the public grid MUST be carried out by a properly-authorized specialist firm.



**CAUTION: High DC voltages are present even low light exposures. NEVER touch bare + or - terminals while the system is in operation.**

### **Potential equalization**

Requirements regarding lightning conductors and excess-voltage protection depend on local conditions. If the building is already fitted with an external lightning conductor (or if one is to be installed), the PV system must be suitably integrated to prevent direct lightning strikes.

If power inverters without a transformer are used, they must be suitably earthed (grounded) to provide personal protection and compensate for the lack of galvanic isolation. Applicable local and national regulations are to be observed in this respect.

The responsibility of the installing company is to ensure a proper potential equalization of the module frames. Land-specific standards must be adhered to.

Connection holes for the equipotential bonding can be found on the short module frame sides and marked with the corresponding symbol.

An M4 screw is specified for equipotential bonding. It must be secured with a split or toothed washer, in order to ensure that the Eloxal finish is properly penetrated.

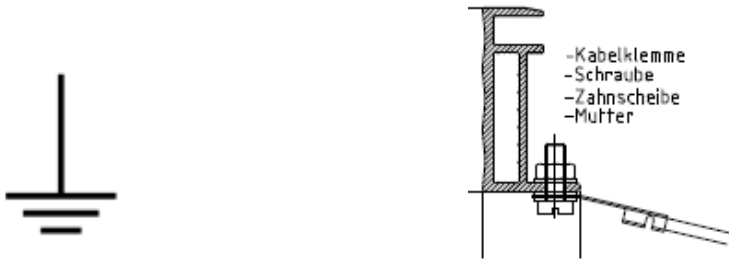

Fig. 5: Equipotential bonding symbol and design

### **Fire prevention**

The installation of solar modules on the roof may affect the fire safety of the building concerned, as incorrect installation can cause a fire hazard. Please follow local planning laws and building regulations. Heckert Solar modules forming part of a rooftop installation must be fitted onto a fire-resistant base material. The module is classed as a "non-explosion-protected" item of equipment. It therefore must not be installed anywhere near to volatile gases and fumes found in places (such as filling stations, gas-storage facilities or paint-spraying workshops). The module must not be installed near open flames or inflammable materials.

Heckert Solar's modules were tested according to IEC 61730-1:2004 and ISO 11525-2:2014. Our modules are normally flammable. Heckert Solar cannot be held responsible for damages due to installation of the modules on unsuitable grounds or roofs.

We recommend the clear documentation of the PV system and the display of a layout plan at the building's power connection box and main distribution point.

### 7: Return and recycling

Return and recycling of solar modules are regulated by the WEEE directive. Please observe country-specific regulations.

EAR registration no. DE42676826

### 8: Product/performance guarantee

For further information on terms and conditions of use and the guaranteed performance specifications of our products, please go to our website on [www.heckertsolar.com](http://www.heckertsolar.com).

### 9: Liability exclusion

These installation and operating instructions apply to general, standard-designed systems. These details are provided for information only, and are not contractual in any way. Heckert Solar GmbH can offer no guarantee as to the suitability or functioning performance of these modules if the user fails to abide by the instructions given in this user information. As Heckert Solar GmbH can in no way control or monitor conformity with this user information, local circumstances, the usage and conditions to which the installation is subject, the manner in which it is operated, or the maintenance of the modules concerned, Heckert Solar GmbH shall accept no liability whatsoever for any loss or damage that might result from incorrect use, installation, operation or maintenance.

In addition, all liability for infringement of patents or other third-party rights that might arise from the operation of these modules is likewise excluded, unless otherwise specifically established in law.

Our Applications Technology Department will be pleased to deal with any further queries that you might have, on +49(0)371/458568-0.

Appendix: Installation instructions Tyco

Heckert Solar GmbH • Carl-von-Bach-Strasse 11 • D-09116 Chemnitz • Germany

## Installation Manual

### 1. Safety Note



- The SOLARLOK connector is to be used only to interconnect firmly fixed cables.
- **Do not disconnect under electrical load!**
- Electrical current path should only be disconnected using approved devices.
- Only cables released from TE Connectivity (TE) are permitted to be used with SOLARLOK component cable assemblies.
- SOLARLOK component cable shall be labelled with label PN 1718077-1 “Do not disconnect under load”.
- To protect against shock, ensure that conductors and their associated connectors are separated from opposite polarity components.
- Unconnected connectors **must** always be protected from pollution (e.g. dust, humidity, foreign particles, etc.), prior to installation. Do not leave unconnected (unprotected) connectors exposed to the environment. The usage of TE connector dust caps is strongly recommended.
- Connectors that are unmated in the field should also be protected from pollutants.
- Do **NOT** use any **oil or lubricants** during mounting.



### 2. Tools

Installer Starter Kit	(1)	Crimping Tool +++	PN	5-1579010-4
Stripping Tool	(2)	2.5 mm <sup>2</sup> - 6.0 mm <sup>2</sup>	PN	4-1579002-2
Crimping Tool	(3)	4.0 mm <sup>2</sup> and 6.0 mm <sup>2</sup>	PN	1-1579004-2
Extraction Tool	(4)	all terminals	PN	1102855-3
Field Service Kit	(5)	all in one	PN	1534858-1

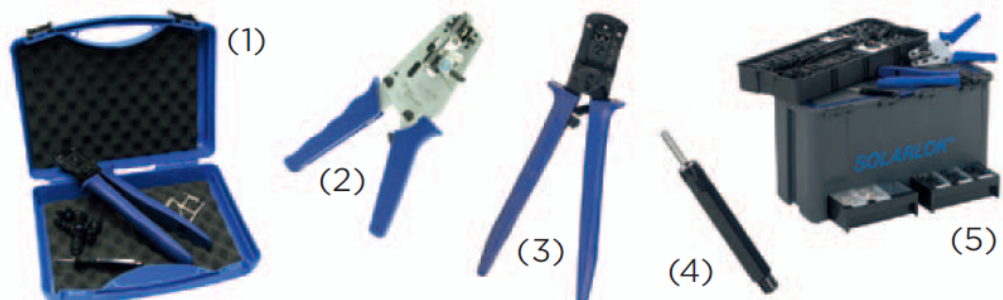

### 3. Assembly Steps

Using appropriate wire stripping tool, strip the wire **9mm ± 1mm** without damaging the strands.



Insert stripped wire into the terminal wire crimp barrel until it stops. While holding the wire in place, squeeze the crimp tool handles together until the ratchet releases.



### 4. Pressed- Assembled

Push contact with cable into the connector housing until you hear the contact give audible click and you feel the contact reach the end position. To verify contact engagement, give a slight gentle pull back on the cable, to be sure that the contact is locked.



### 5. Wiring

Radius (r) min. 5 cable

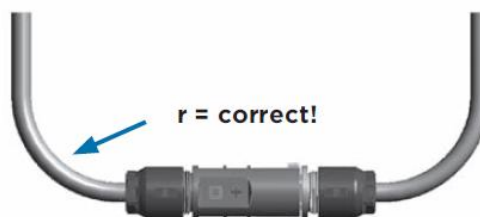

## **Warranty Conditions of Heckert Solar GmbH, Chemnitz/Germany, for Crystalline Solar Modules.**

### **1. Product warranty**

- 1.1. Heckert Solar GmbH (hereinafter referred to as Heckert Solar) warrants for the delivered standard modules that they are free from material and manufacturing faults (extended warranty). A natural detraction is not taken as a fault.
- 1.2. The product warranty is granted for 11 years, beginning with the delivery to the contractual partner of Heckert Solar.
- 1.3. Warranty covers (at the option of Heckert Solar) repair, replacement delivery of identical or similar modules as regards power class or refund of purchase price. The overall performance of the modules to be replaced is decisive. Warranty excludes costs for dismantling, transport and re-installation of modules as well as costs arising from loss of earnings due to yield reduction. Further claims, in particular compensation claims, are excluded, too. Replaced modules shall become the property of Heckert Solar.
- 1.4. As Heckert Solar uses only solar glass of a very high quality, damages can only be caused by mechanical impact. Therefore, Heckert Solar assumes no warranty for the solar glass. Furthermore, product warranty does not cover abrasion such as scratches, spots, rust and discolorations.

### **2. Performance warranty**

- 2.1. Heckert Solar insures that the solar modules produce
  - at least 90% during a period of 10 years and
  - at least 80% during a period of 25 yearsof the minimum performance registered in the respective data sheet (in consideration of the usual measuring tolerances). These periods are valid as from delivery to the contractual partner of Heckert Solar.
- 2.2. Warranty basis is the measurement of module performance by Heckert Solar with own measuring devices under standard measuring conditions (according to IEC EN 61215 and 60903-3).
- 2.3. Performance warranty shall always enter into force when the solar modules produce demonstrably less power than the above-mentioned percentage figures of the minimum power due to aging effects of cells, glass or embedding foil.
- 2.4. Warranty comprises, at the option of Heckert Solar, the delivery of additional or replacement of modules with new or repaired modules or partial refund of purchase price. Provided that the originally delivered module type is no longer produced in series, substitute modules or additional modules of the respective current standard types are delivered. Warranty excludes costs for dismantling, transport and re-installation of modules as well as costs arising from loss of earnings due to yield reduction. Further claims, in particular compensation claims, are excluded, too.

### **3. Product and performance warranty is excluded,**

- if the defect of a solar module was caused by system components like cables, inverters, connectors etc.;
- if performance fault is caused by overvoltage, flash of lightning, inundation, fire or similar events;
- if the modules are damaged by abuse, negligence, accident, vermin, mechanical impacts or force majeure;
- if the modules are damaged, destroyed or affected by improper installation, utilization, usage operation, storage or transport, by soiling or usage under inappropriate environmental conditions;
- if the solar module was exposed to any kind of technical manipulations;
- if the modules were exposed to interventions of third persons;
- if serial numbers or type signs were exposed to manipulations or if the modules cannot be clearly identified for other reasons;
- if the modules are not operating in the plant where they have been installed for the first time or if they operate on mobile objects like vehicles or ships.
- Warranty period shall not be prolonged by additional or replacing deliveries.

### **4. Validity of warranty rights**

- 4.1. Warranty conditions can only become valid upon presentation of delivery note as well as respective invoice issued by Heckert Solar or the seller and by submission of the completed form "Reklamation" (PDF-file to be downloaded at [www.heckert-solar.com/Downloads](http://www.heckert-solar.com/Downloads)). These documents shall be presented to Heckert Solar or to the contractual partner of Heckert Solar in order to assert the claim.
- 4.2. Obvious damages have to be shown immediately to Heckert Solar in writing, latest within 7 days after receipt of the goods; not-obvious damages at discovery. Returned damaged modules will not be accepted without prior demand in written issued by Heckert Solar.

Further claims apart from the above-mentioned are excluded, in particular those on damage claims, which have not originated on the modules delivered. This shall not apply unless in case of intention, culpable negligence, absence of warranted characteristics and the culpable violation of essential contractual obligations according to the law imperative liability is being provided. Heckert Solar also accepts no liability for other compensation claims by the contractual partner due to positive infringement of contract, neglect of duties in contract negotiations or prohibited actions, as far as there is no mandatory liability for Heckert Solar, its representatives and servants based upon their intent or gross negligence. Heckert Solar excludes consequential damages, as well.
- 4.3. The period of limitation of damage claims shall be 6 months, beginning with passing of the risk, yet no later than 6 months after the damage has occurred.

This warranty replaces any previously given English versions and is valid regardless of any other legal specifications applying in Europe and Switzerland. The claims granted on the basis of this warranty declaration are subject exclusively to German law. Place of jurisdiction is Chemnitz.

Valid from June 1<sup>st</sup>. 2018.