

Tisch 2x6 - auf Beton

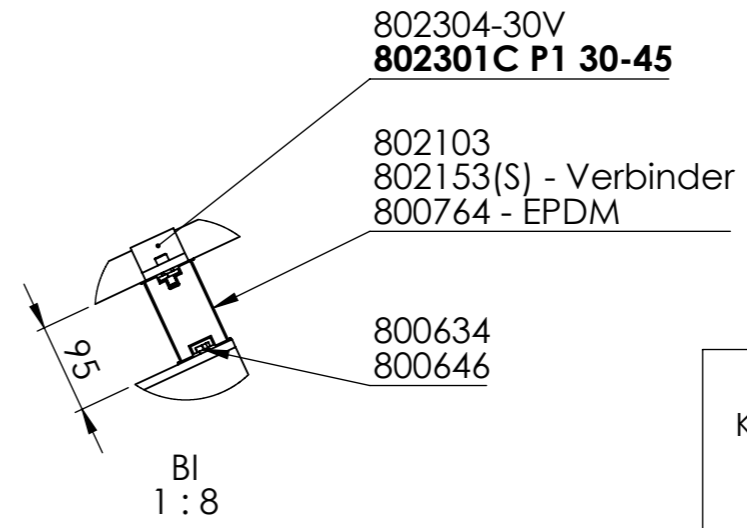

Schneelast: **sk = 1.80 kN/m²**
 Windlast: **qp = 0.65 kN/m²**

Kąt / Winkel / Angle	Otwór (od środka) / Loch (von innen) / Hole (from the center)
10°	1-2
12,5°	2-3
15°	3-4
17,5°	4-5
20°	5-6
22,5°	6-7
25°	7-8
27,5°	8-9
30°	9-10

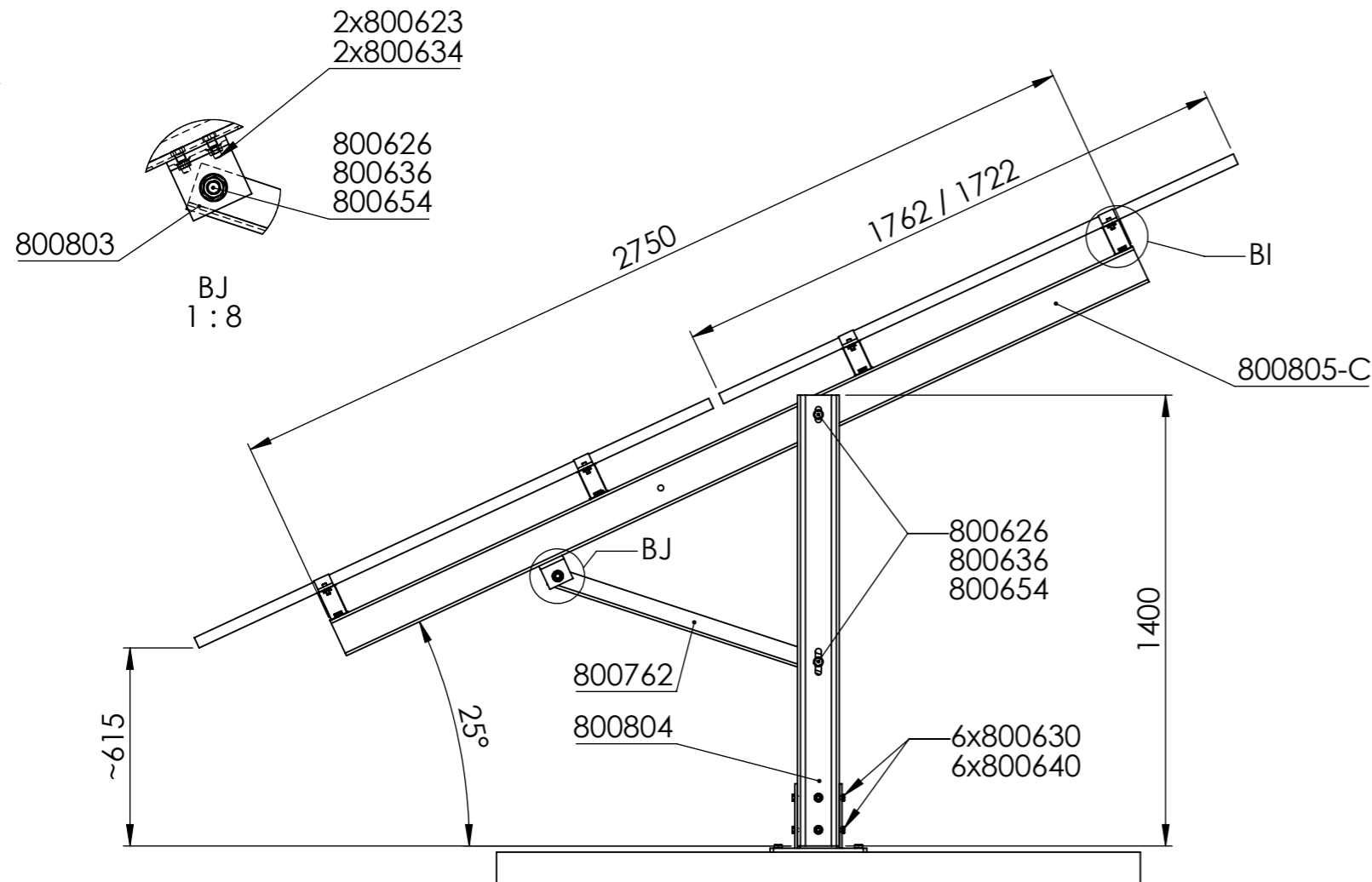
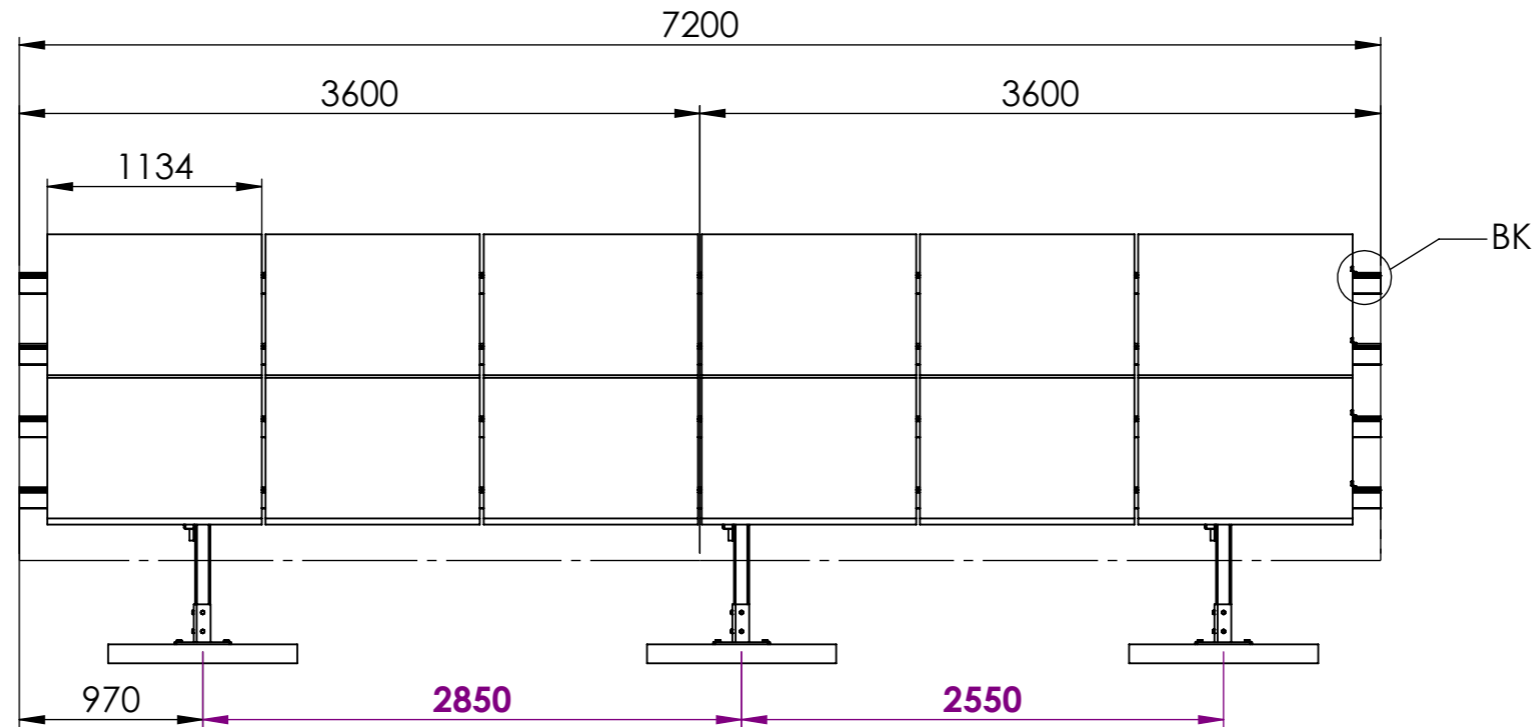

INDEKS/INDEX: -
2x6 - 2x20
 AUTOR: Szymon Pluta
 DATA/DATUM: 24.04.2023

PROJEKT: Freiland kits für Memodo
 A3